

THE STATE OF DELAWARE



DEPARTMENT OF TRANSPORTATION  
MAINTENANCE AND OPERATIONS  
CONSTRUCTION PLANS AND SPECIFICATIONS FOR

SUBDIVISION PAVING, NEW CASTLE COUNTY VI, 2025

CONTRACT NUMBER - T202504906

UNIFIER PROJECT ID – 2025-00043

FEDERAL AID NUMBER - NONE

COUNTY: NEW CASTLE

PLANS PREPARED BY:   
DESIGNER

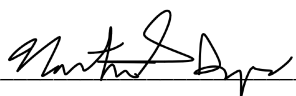
 11/13/24  
DELDOT – PUBLIC WORKS ENGINEER/PM II DATE  
MAINTENANCE AND OPERATIONS - (CAD)

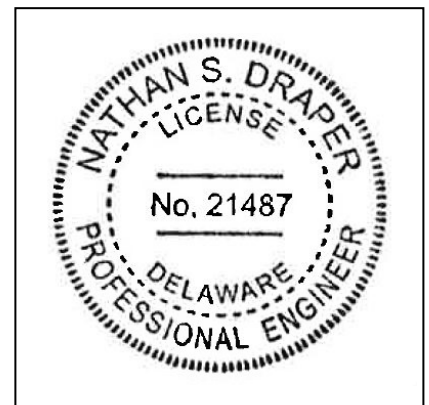

THIS SEAL APPLIES TO ALL SHEETS  
BEARING THE "CAD" SECTION  
DESIGNATION

APPROVED FOR ADVERTISEMENT

Anne Brown 11/14/2024  
DIRECTOR OF MAINTENANCE AND OPERATIONS DATE

---

DEPARTMENT OF TRANSPORTATION

---

CONTRACT NUMBER- T202504906

(CAD) PAGE 2 OF 84

---

Contract is for various locations throughout New Castle County.

---

LOCATION MAP

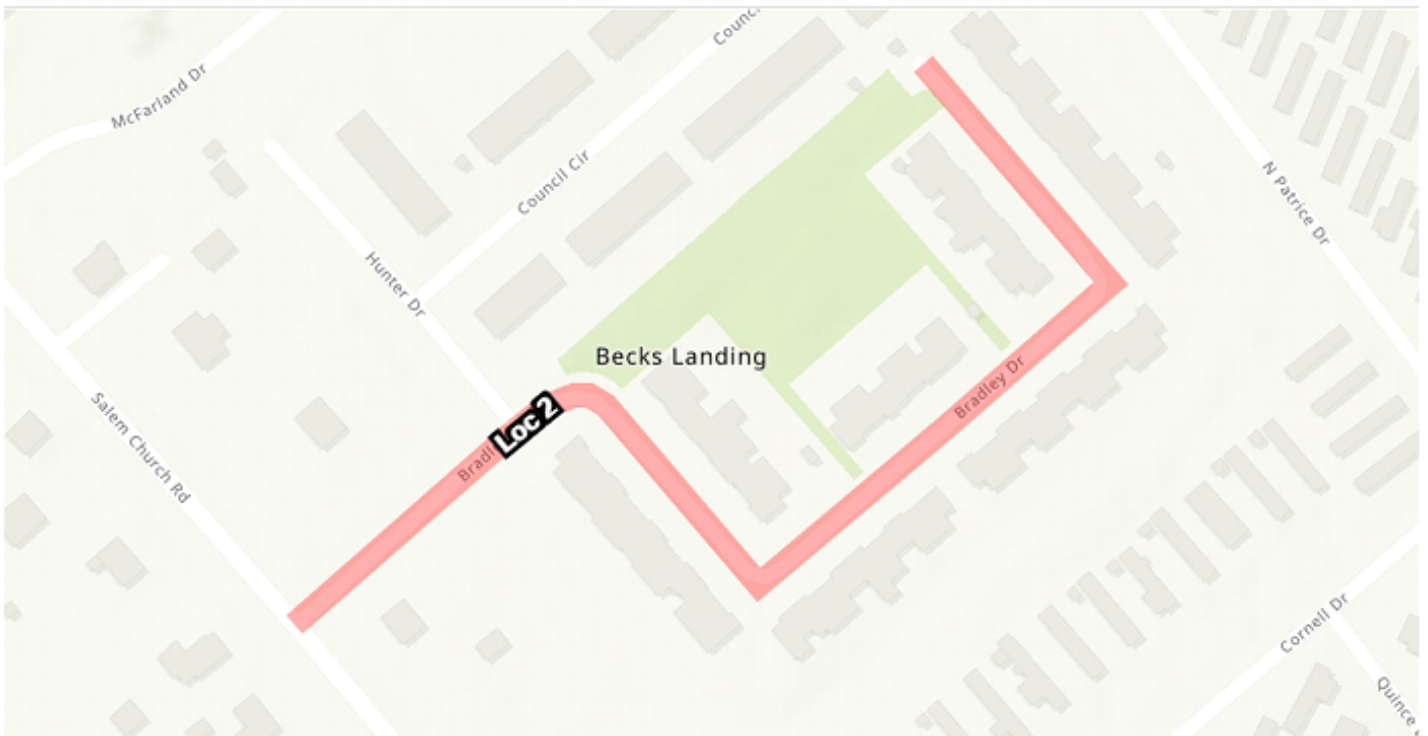
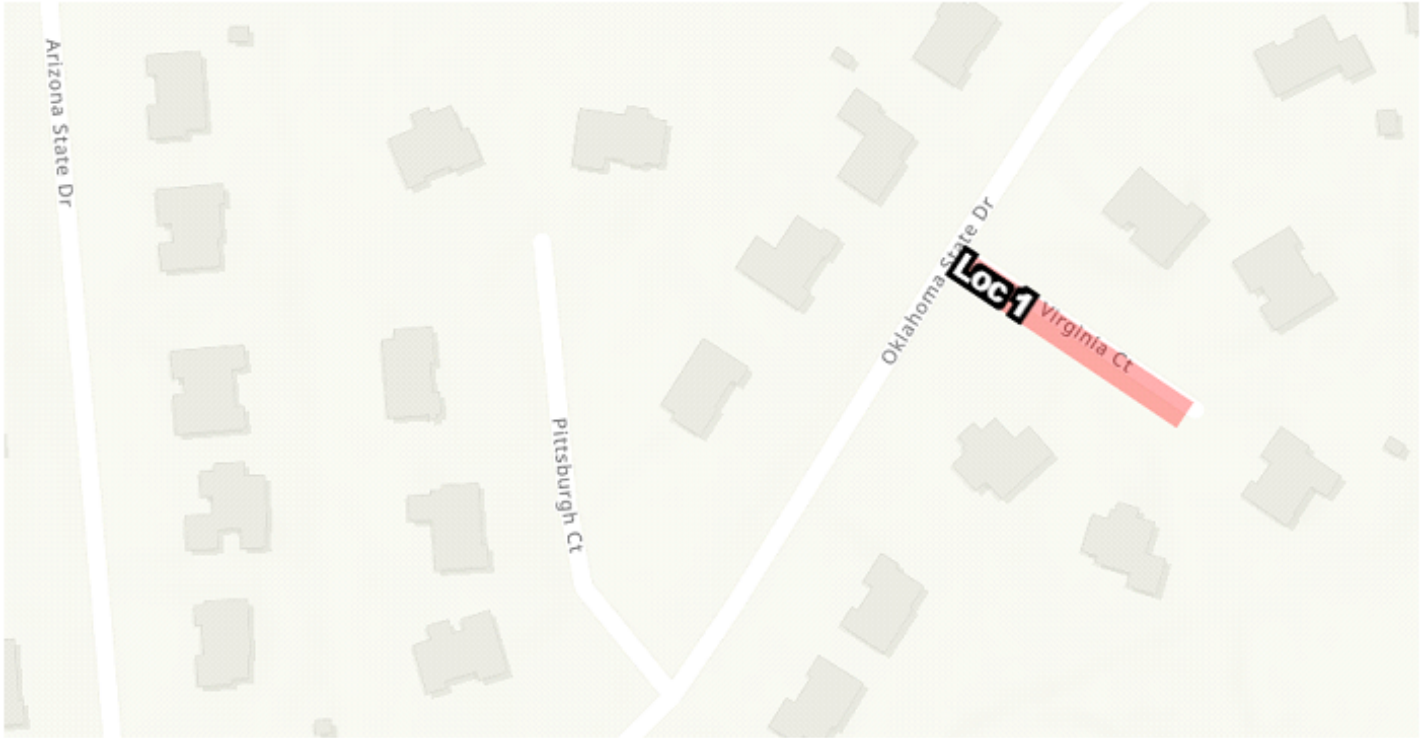

---

DEPARTMENT OF TRANSPORTATION

---

CONTRACT NUMBER- T202504906

(CAD) PAGE 3 OF 84

---

Contract is for various locations throughout New Castle County.

---

LOCATION MAP

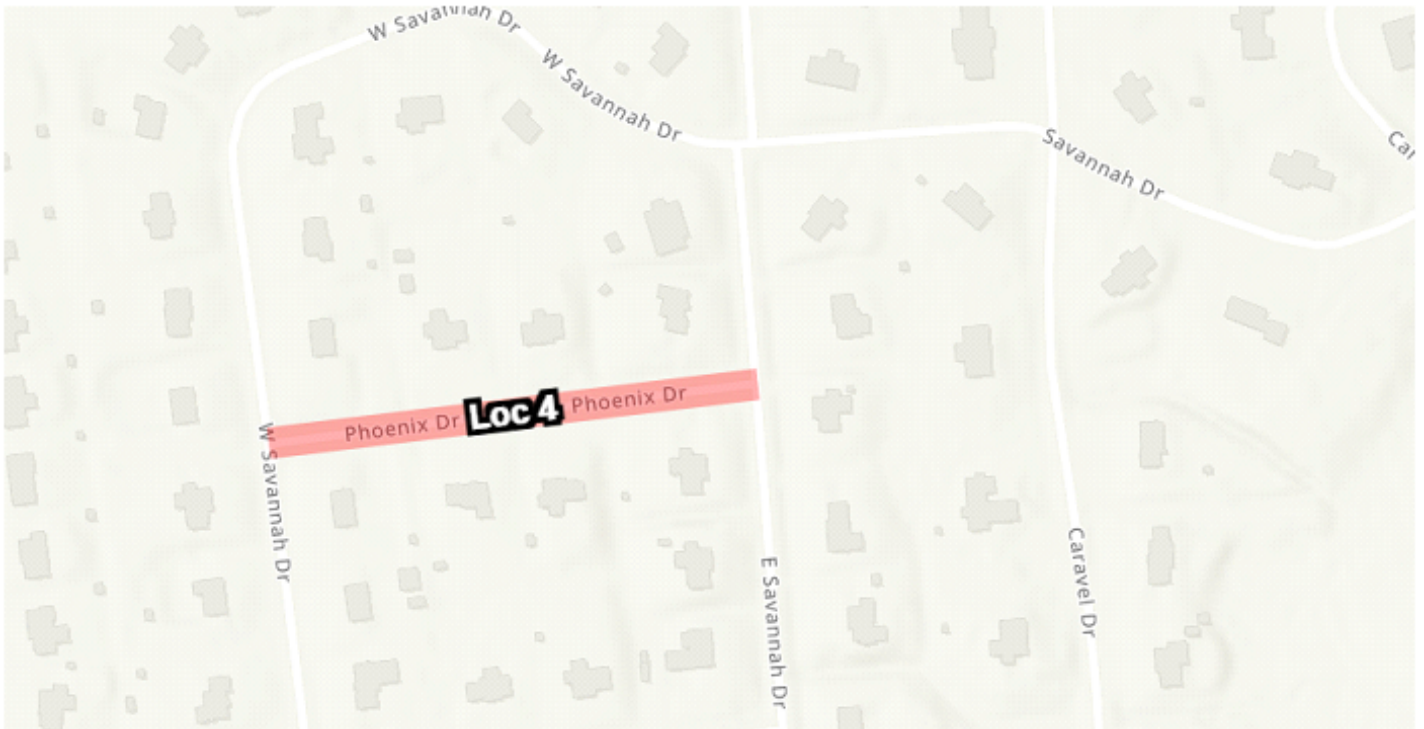
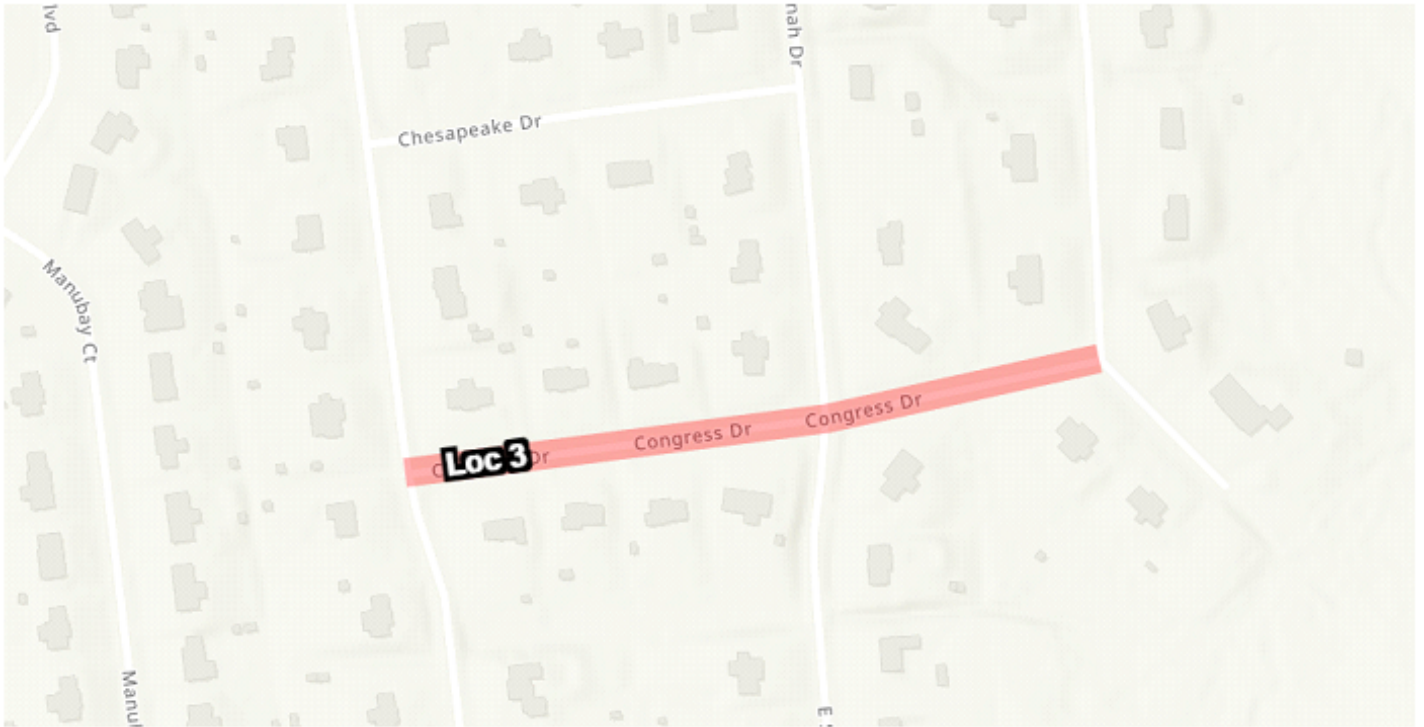

DEPARTMENT OF TRANSPORTATION

CONTRACT NUMBER- T202504906

(CAD) PAGE 4 OF 84

Contract is for various locations throughout New Castle County.

LOCATION MAP

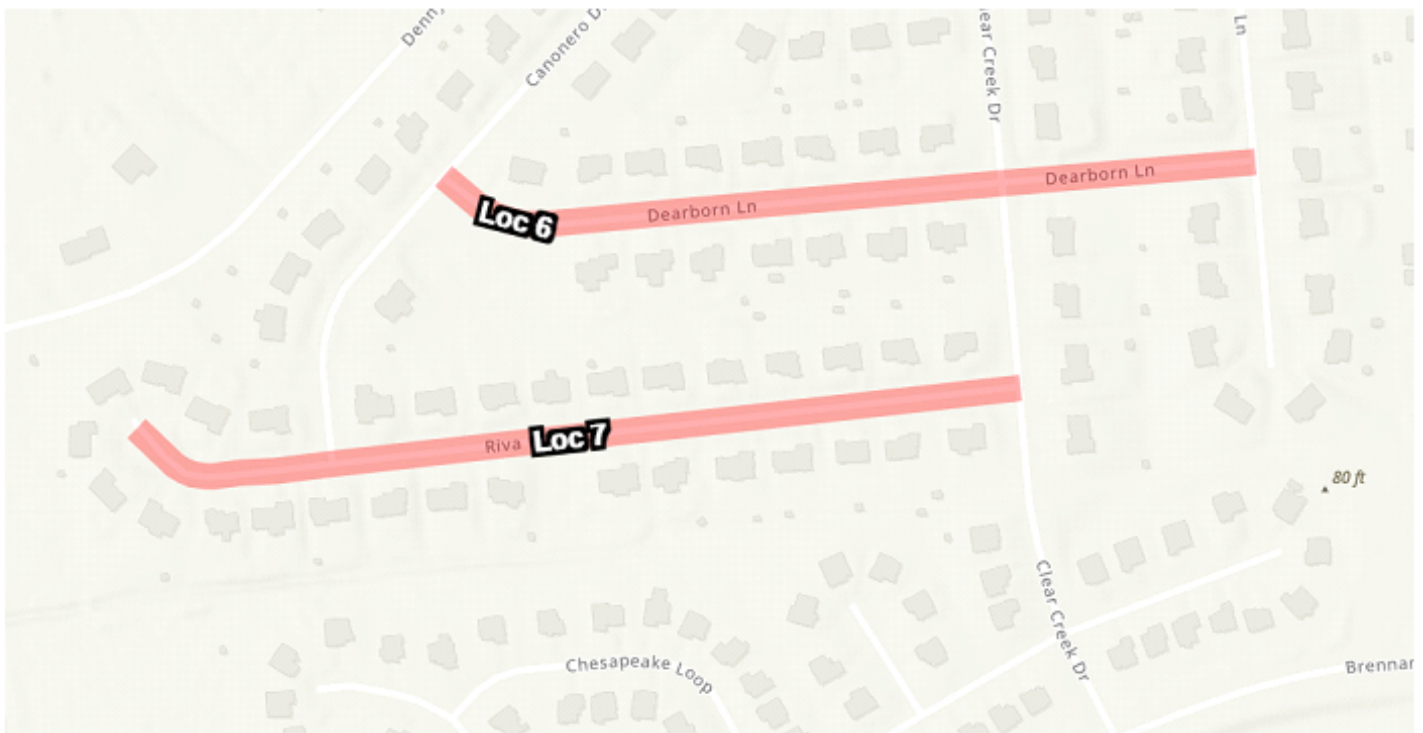
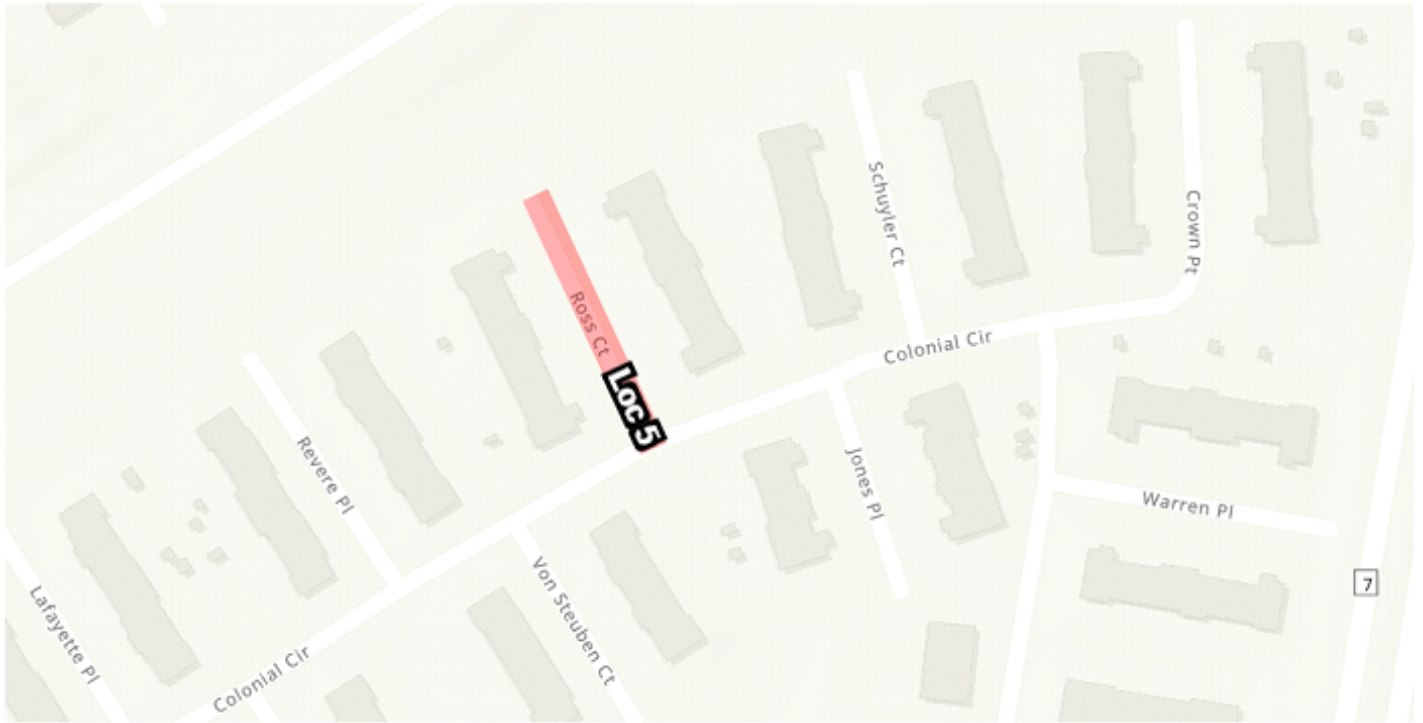

---

DEPARTMENT OF TRANSPORTATION

---

CONTRACT NUMBER- T202504906

(CAD) PAGE 5 OF 84

---

Contract is for various locations throughout New Castle County.

---

LOCATION MAP

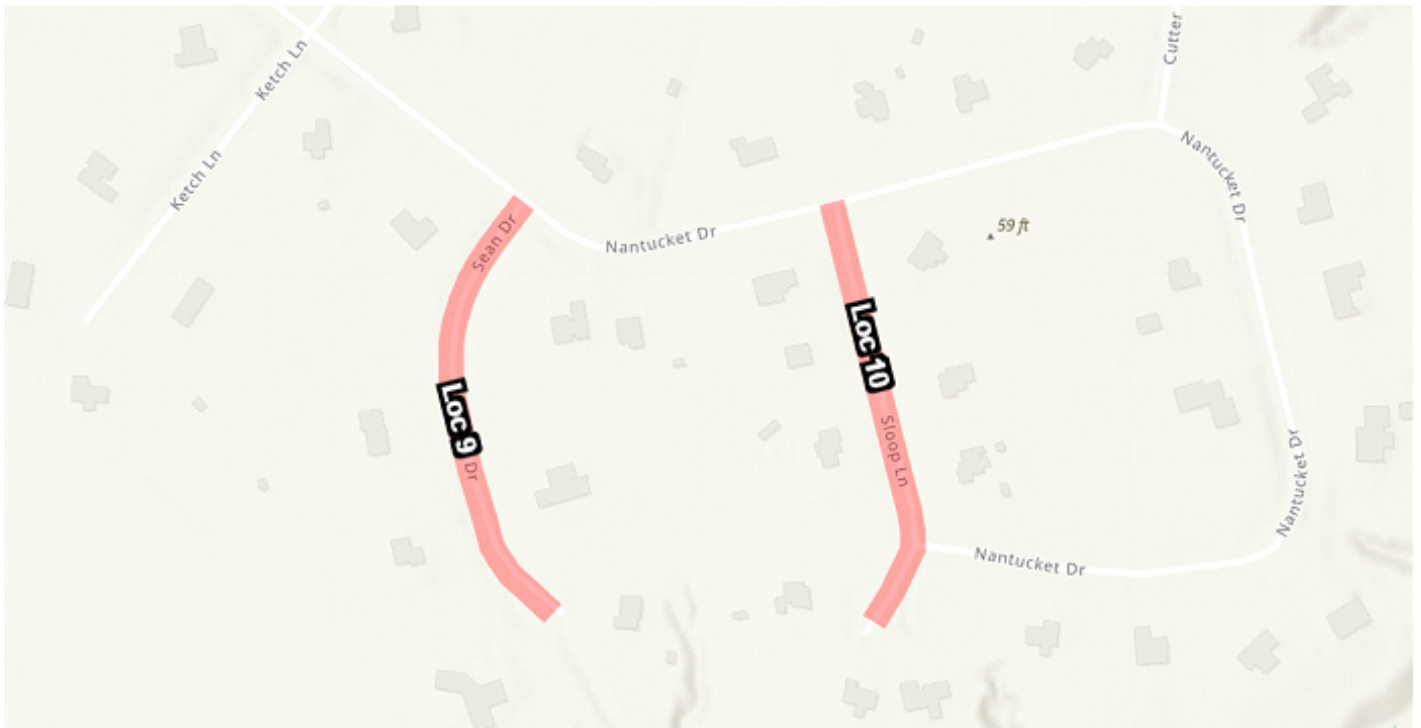

---

DEPARTMENT OF TRANSPORTATION

---

CONTRACT NUMBER- T202504906

(CAD) PAGE 6 OF 84

---

Contract is for various locations throughout New Castle County.

---

LOCATION MAP

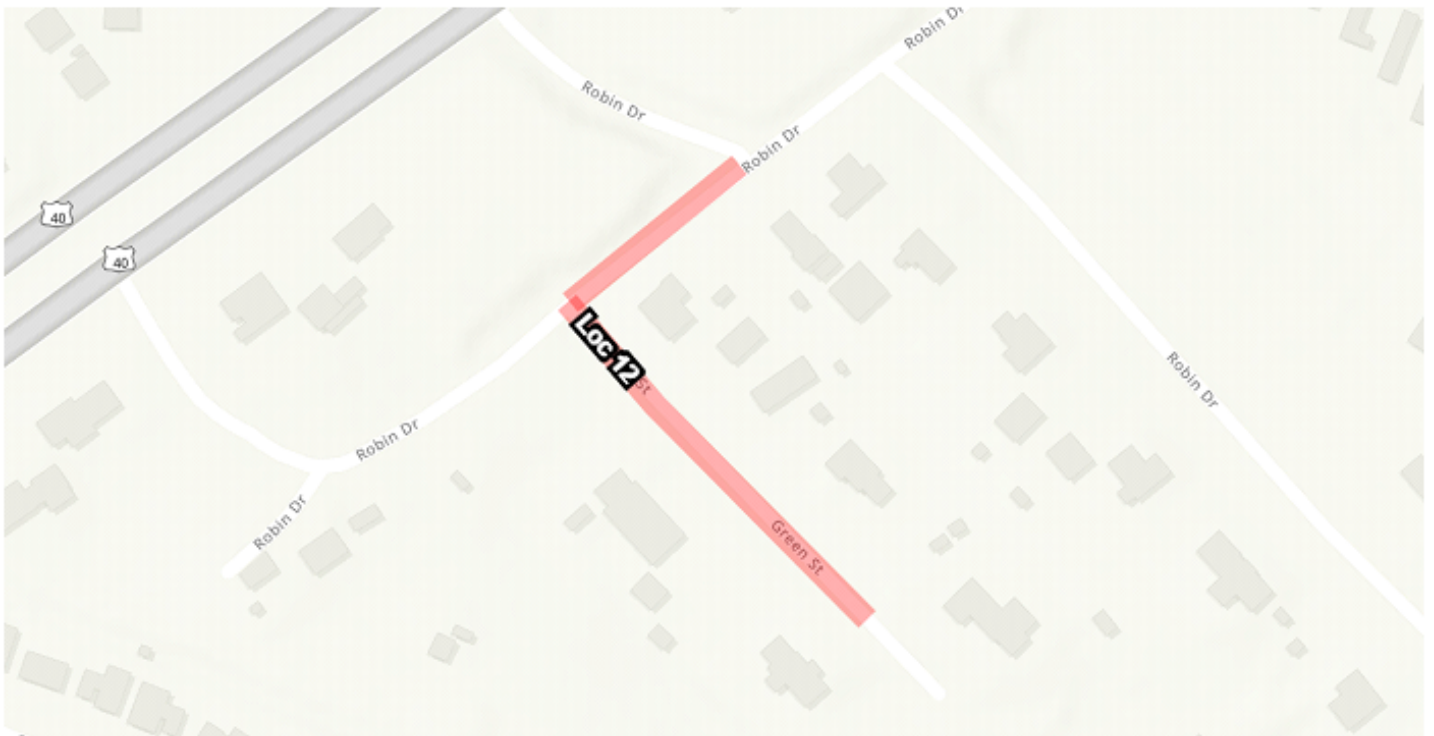
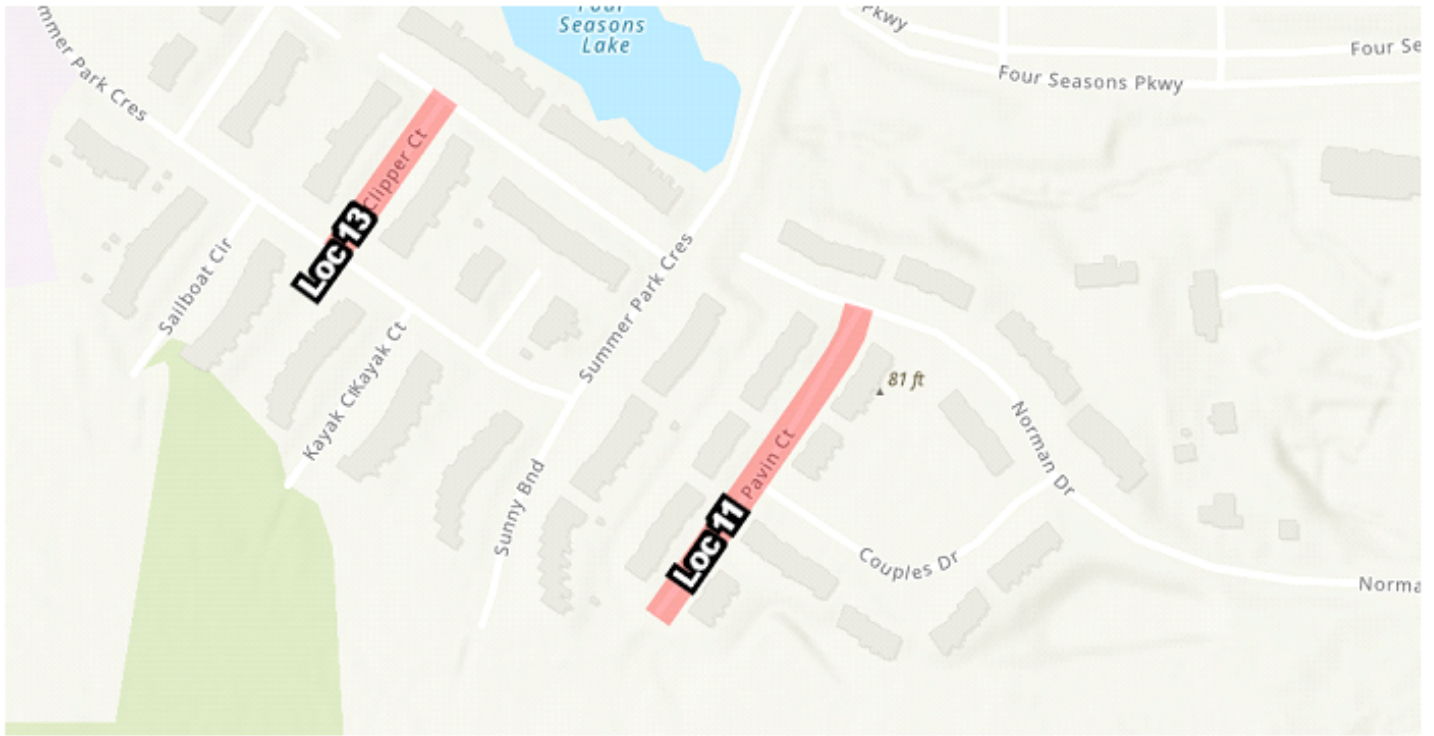

---

DEPARTMENT OF TRANSPORTATION

---

CONTRACT NUMBER- T202504906

(CAD) PAGE 7 OF 84

---

Contract is for various locations throughout New Castle County.

---

LOCATION MAP

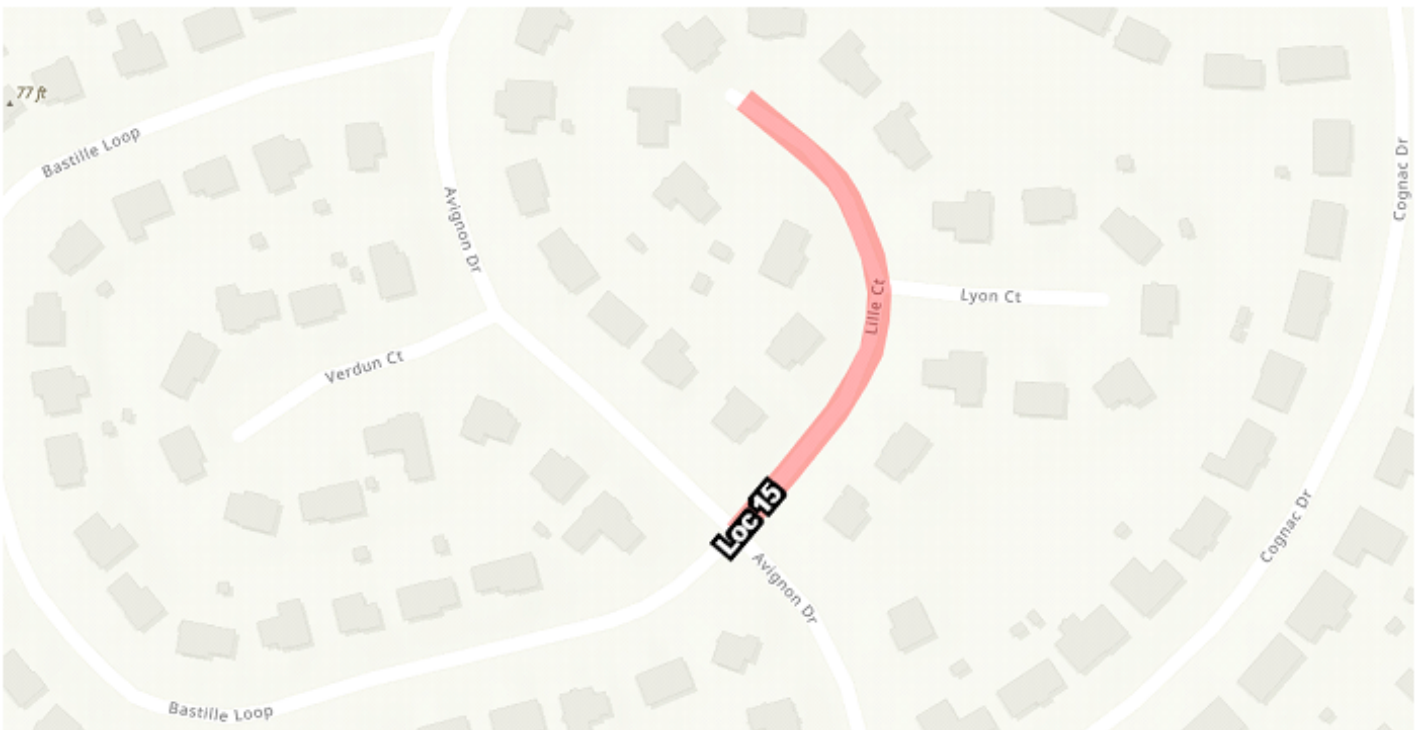
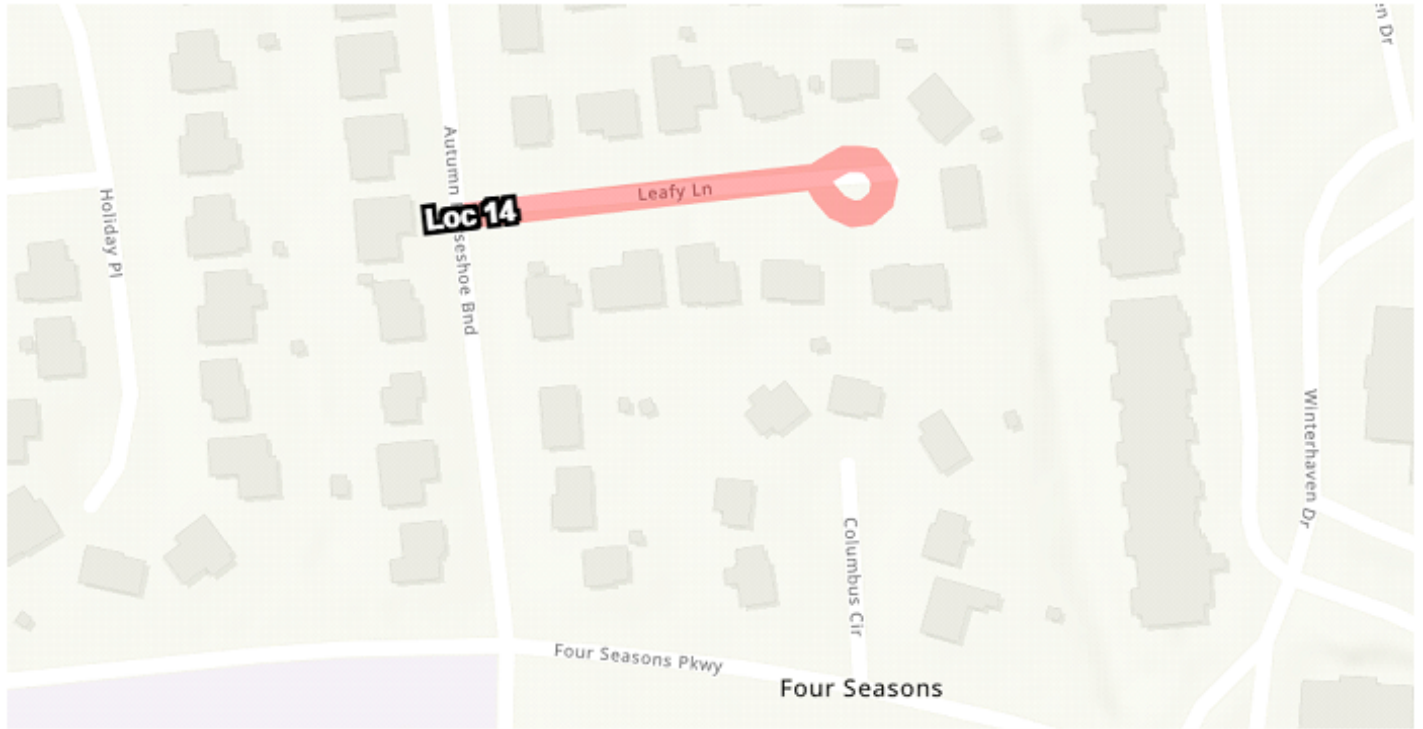

---

DEPARTMENT OF TRANSPORTATION

---

CONTRACT NUMBER- T202504906

(CAD) PAGE 8 OF 84

---

Contract is for various locations throughout New Castle County.

---

LOCATION MAP

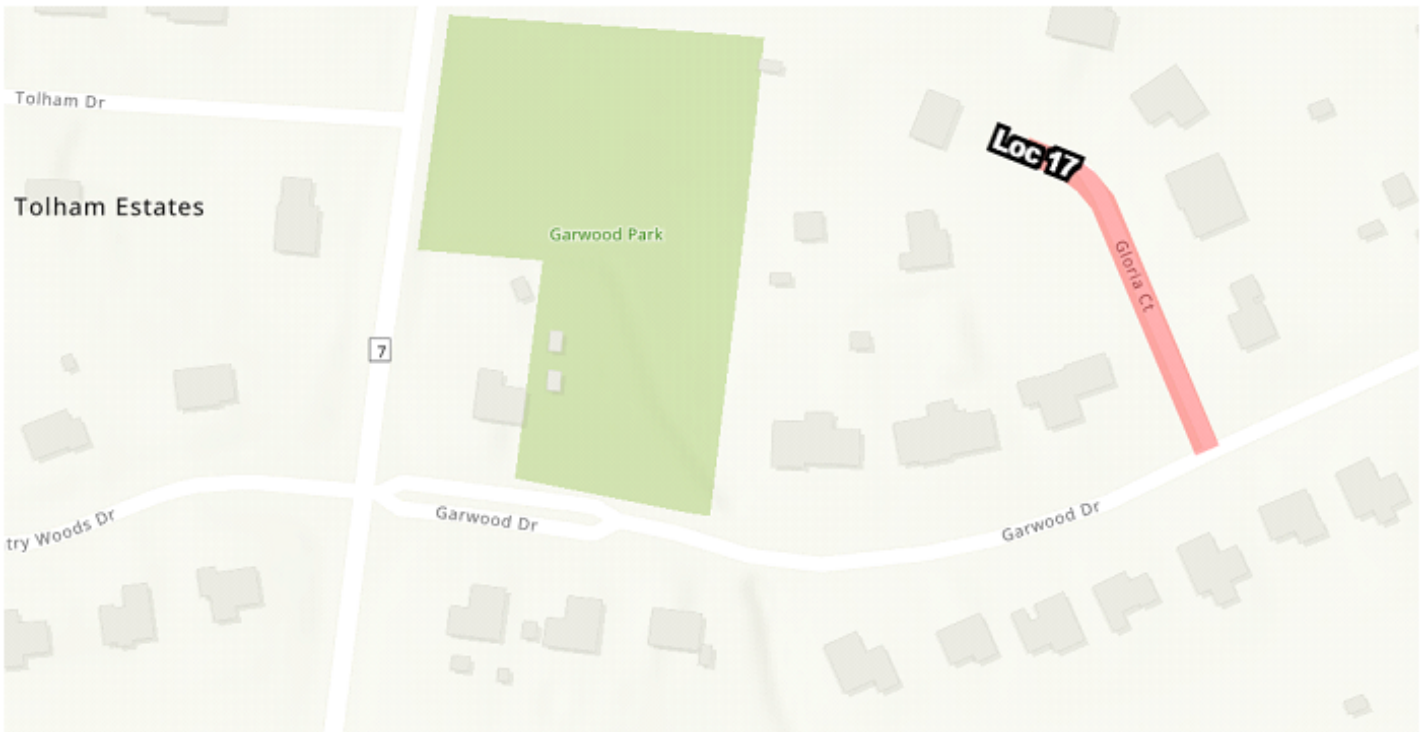
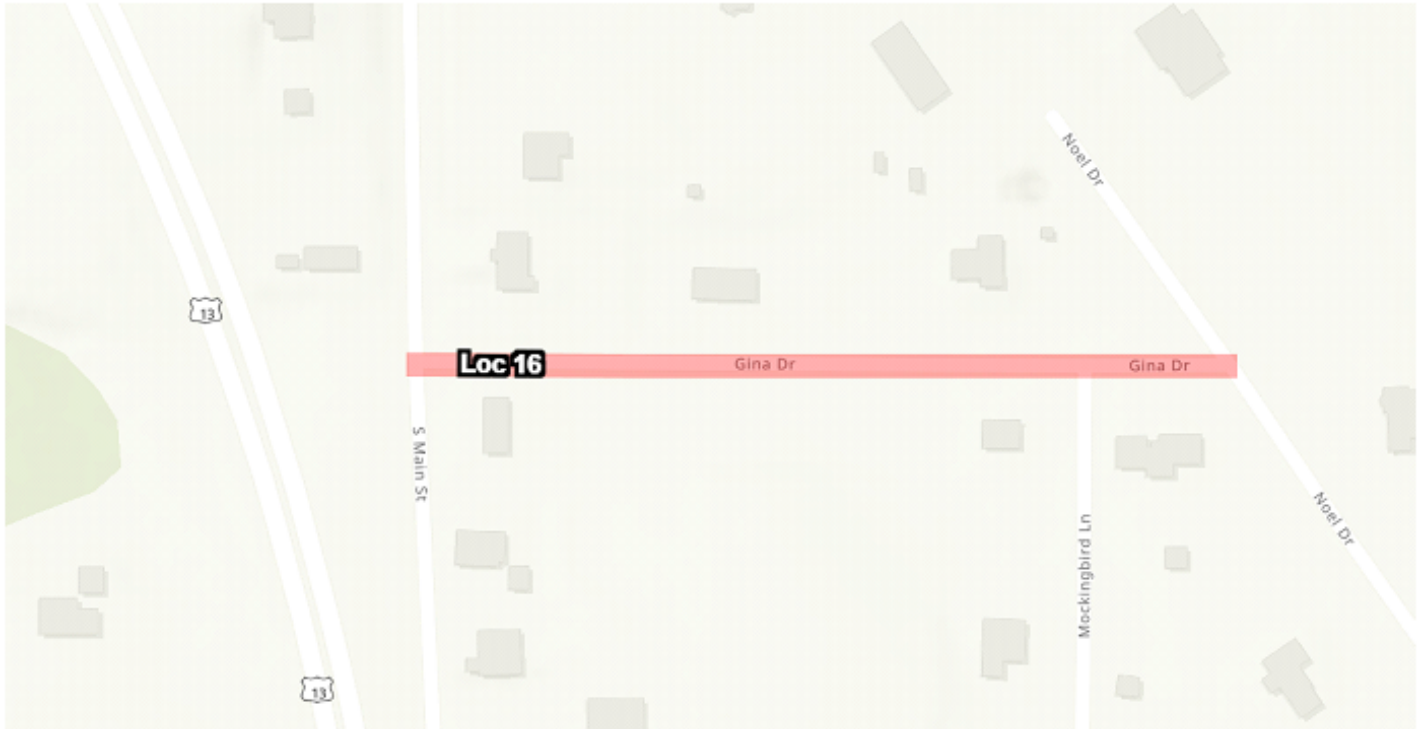

DEPARTMENT OF TRANSPORTATION

CONTRACT NUMBER- T202504906

(CAD) PAGE 9 OF 84

Contract is for various locations throughout New Castle County.

LOCATION MAP

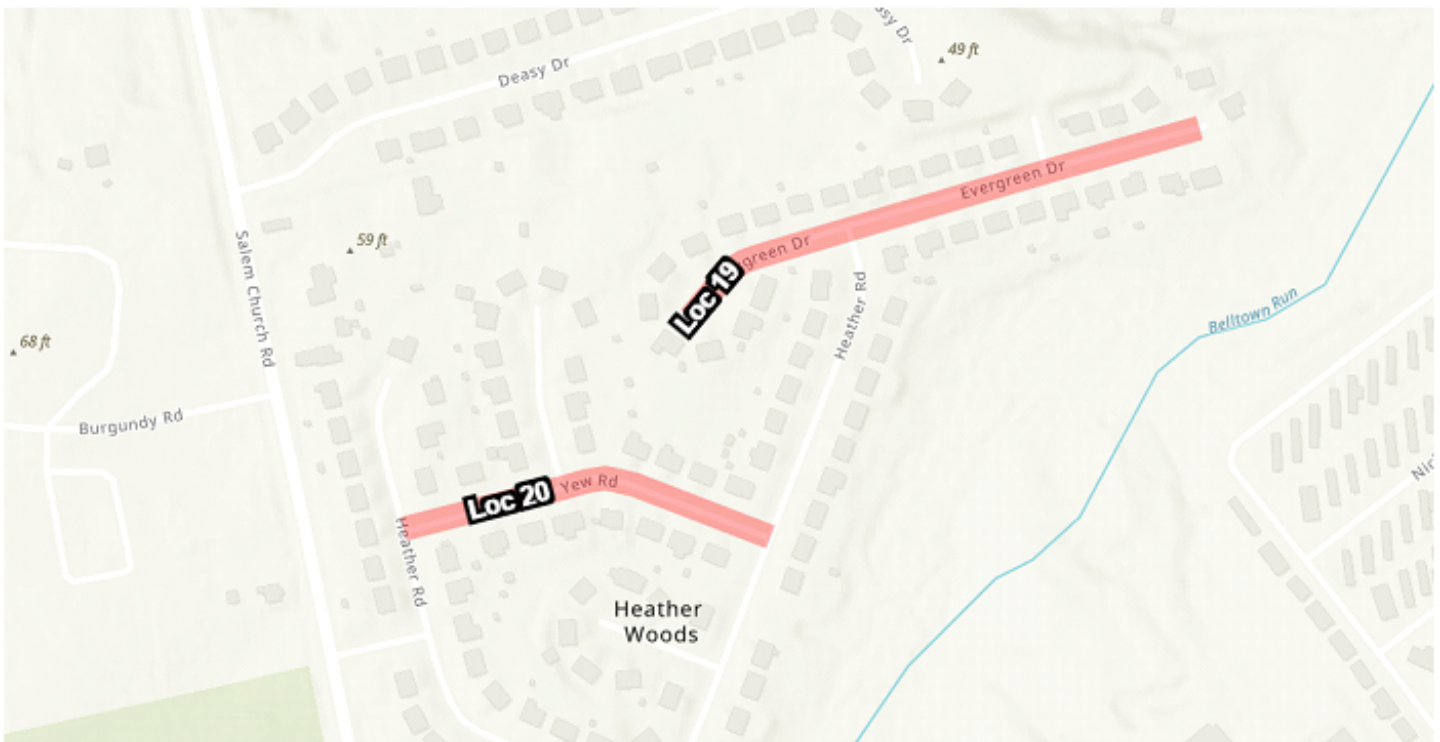
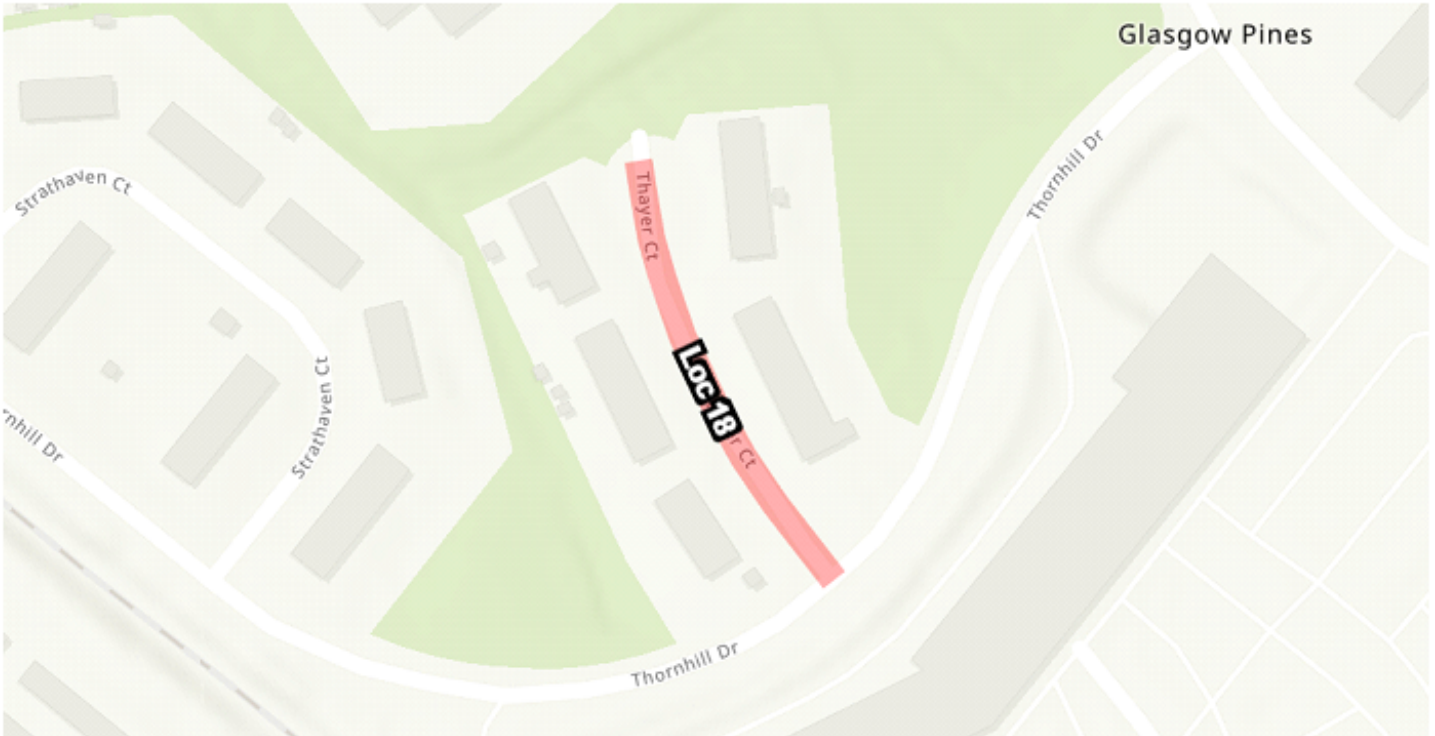

---

DEPARTMENT OF TRANSPORTATION

---

CONTRACT NUMBER- T202504906

(CAD) PAGE 10 OF 84

---

Contract is for various locations throughout New Castle County.

---

LOCATION MAP

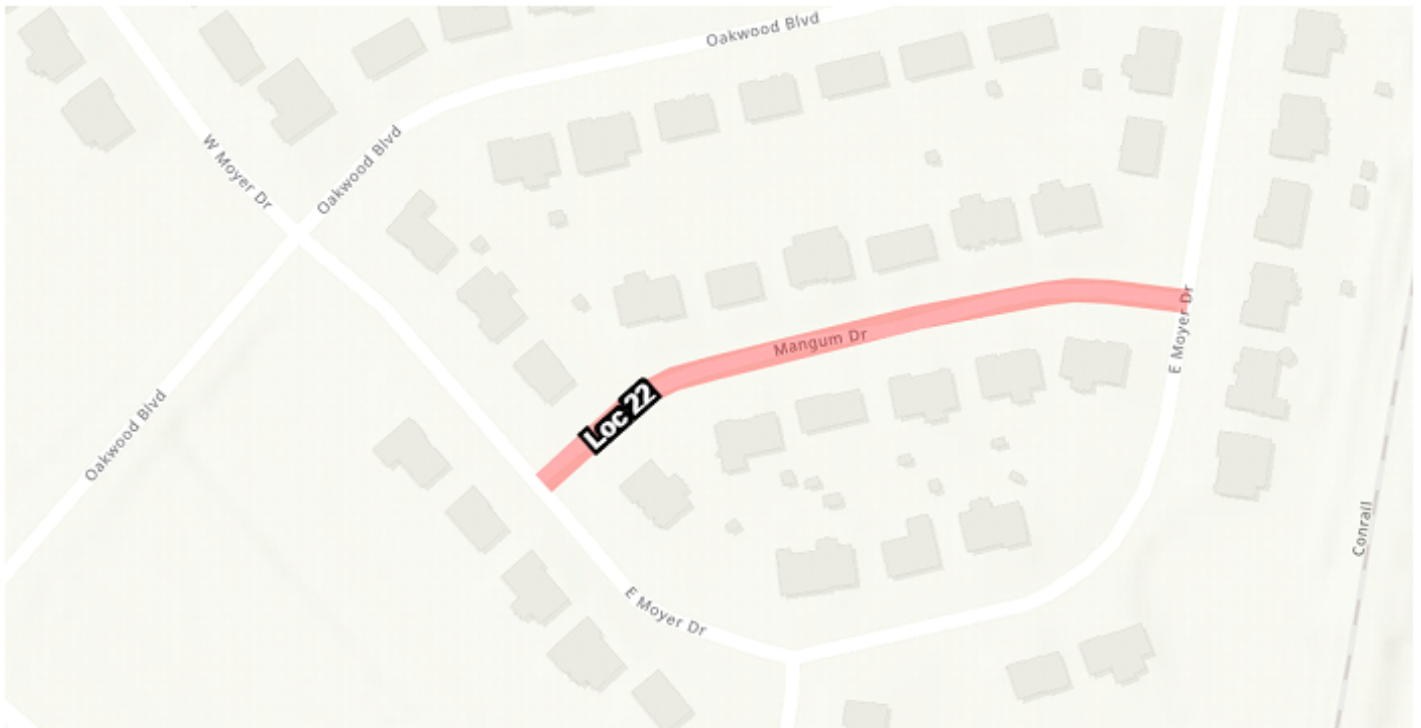
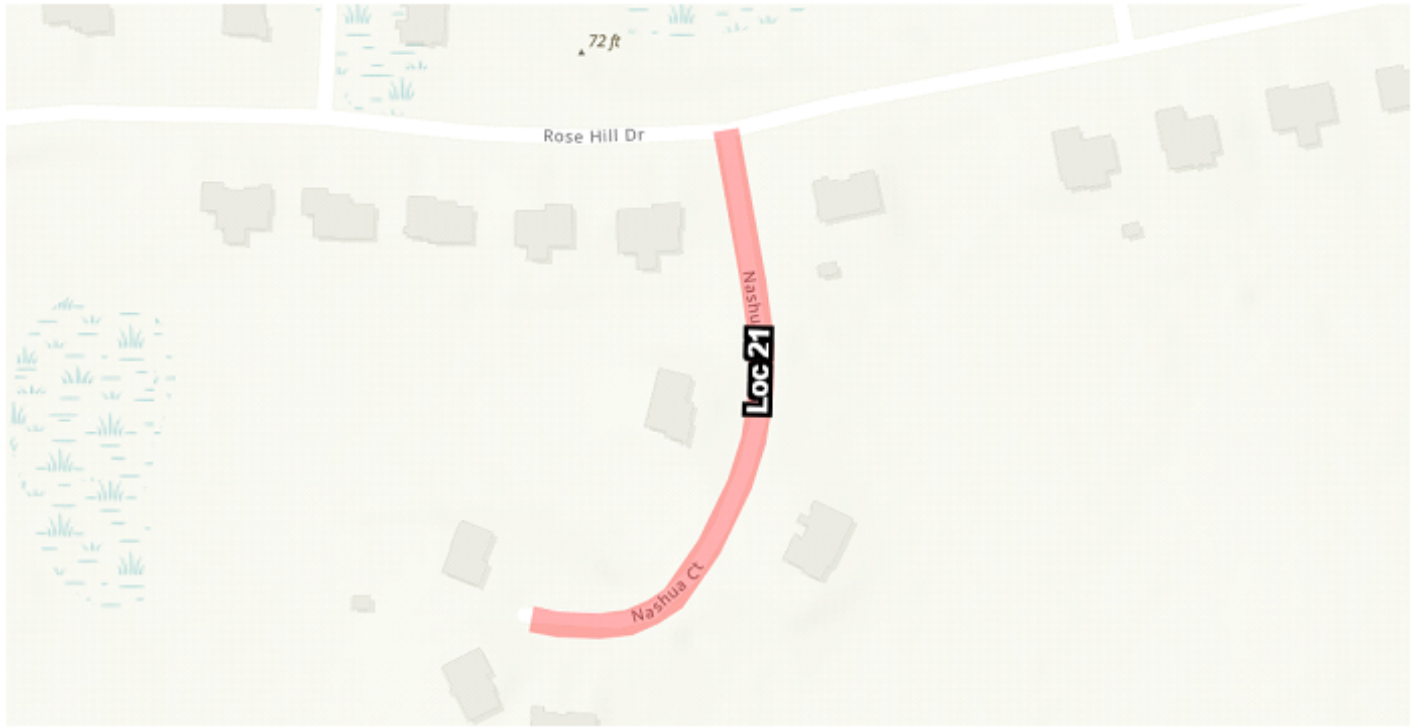

DEPARTMENT OF TRANSPORTATION

CONTRACT NUMBER- T202504906

(CAD) PAGE 11 OF 84

Contract is for various locations throughout New Castle County.

LOCATION MAP

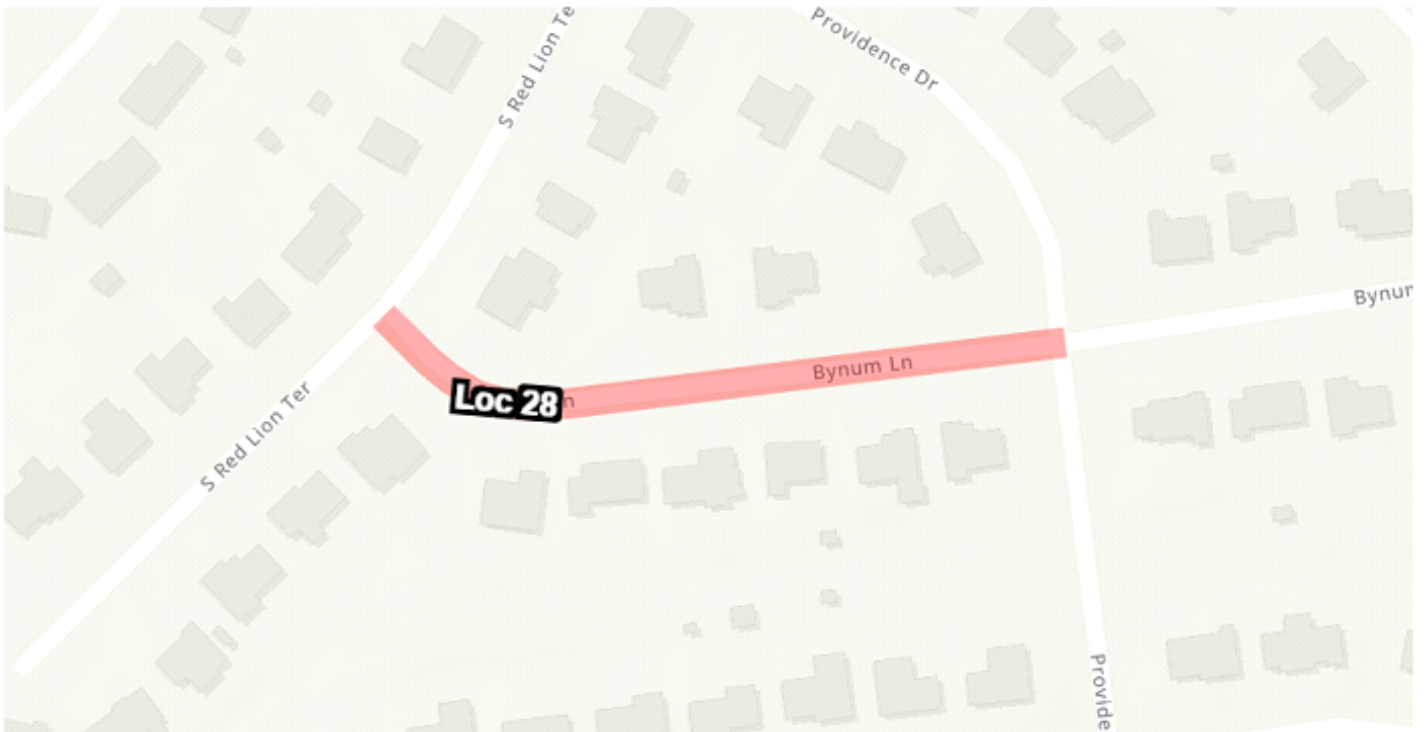
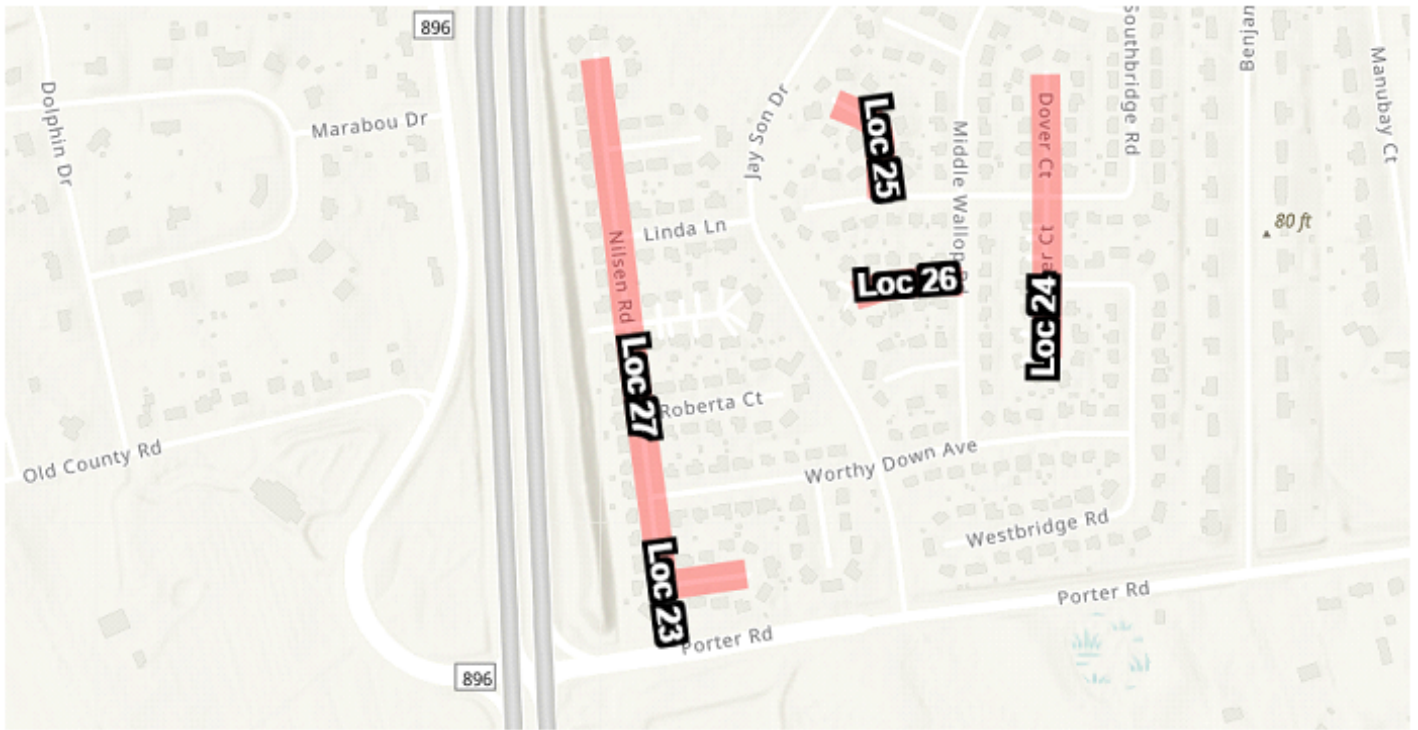

---

DEPARTMENT OF TRANSPORTATION

---

CONTRACT NUMBER- T202504906

(CAD) PAGE 12 OF 84

---

Contract is for various locations throughout New Castle County.

---

LOCATION MAP

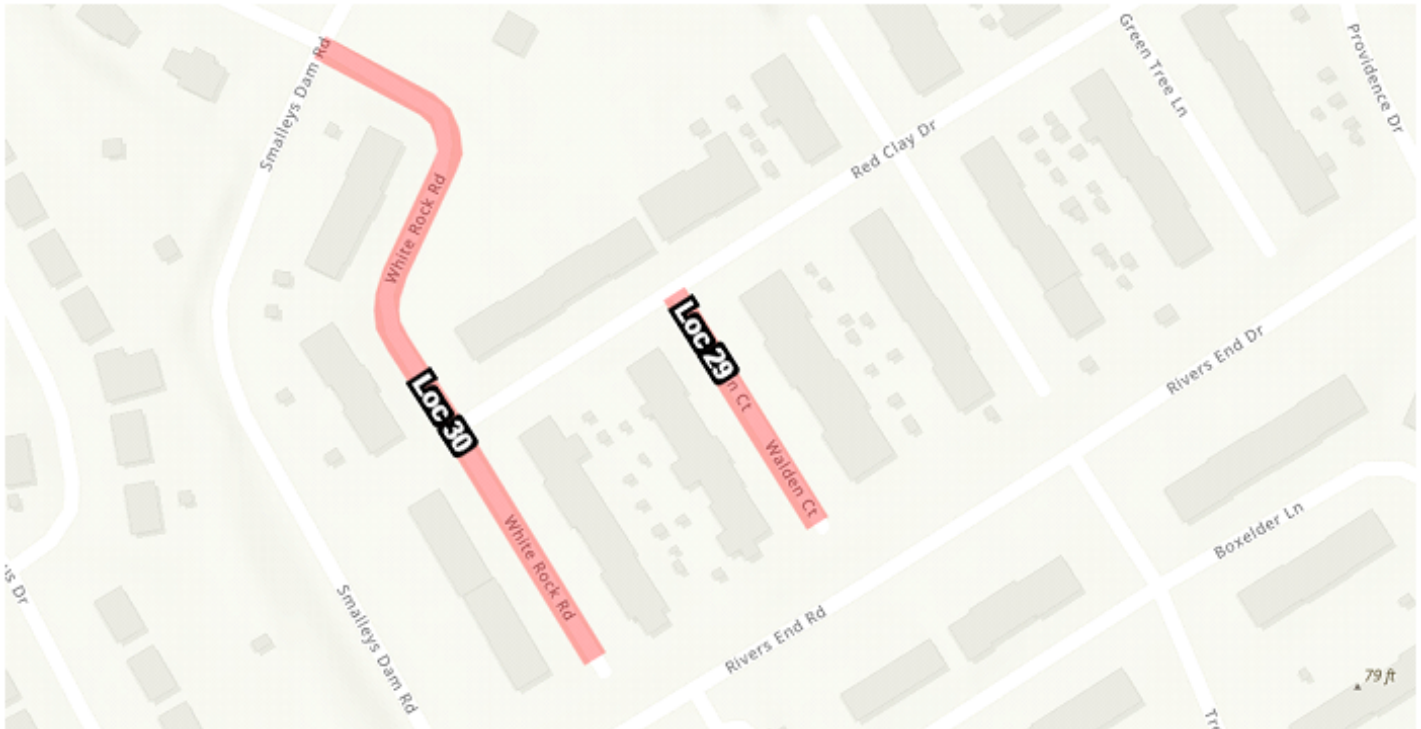
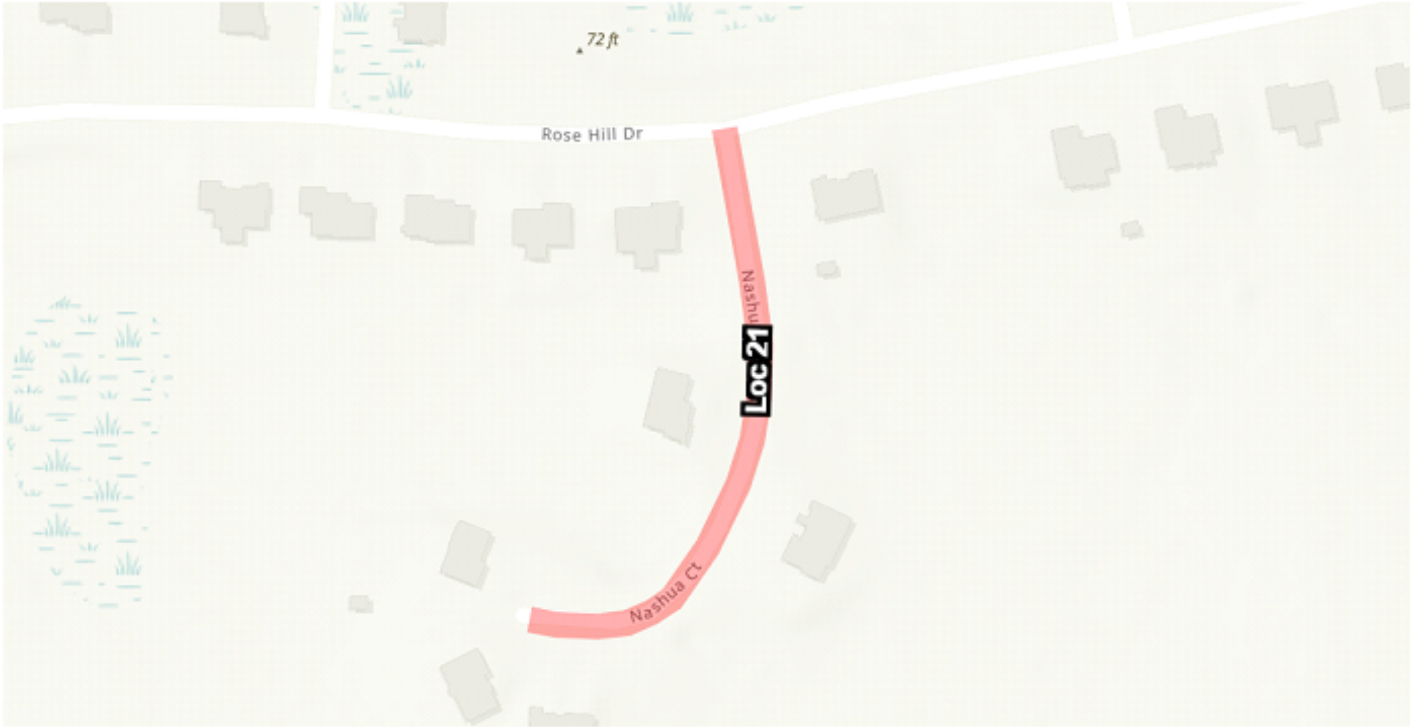

---

DEPARTMENT OF TRANSPORTATION

---

CONTRACT NUMBER- T202504906

(CAD) PAGE 13 OF 84

---

Contract is for various locations throughout New Castle County.

---

LOCATION MAP

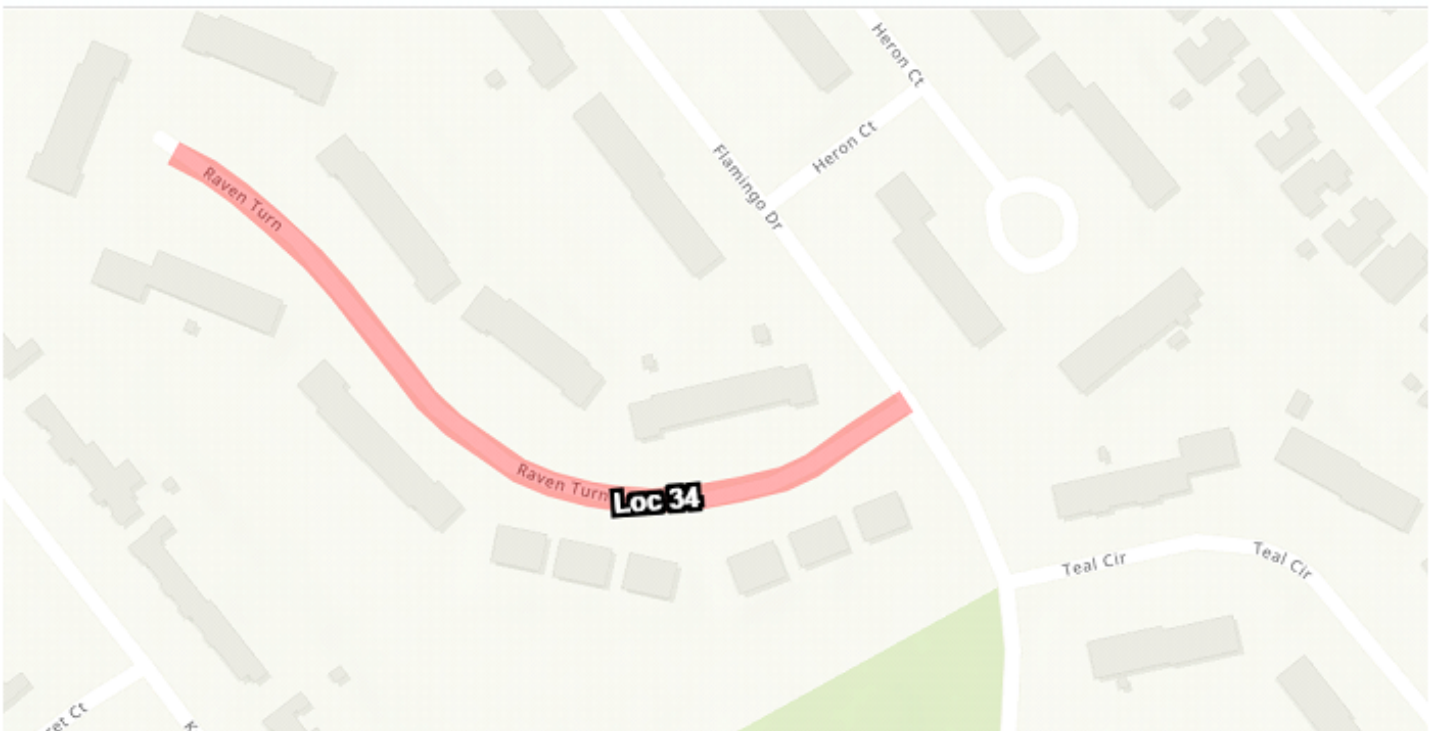
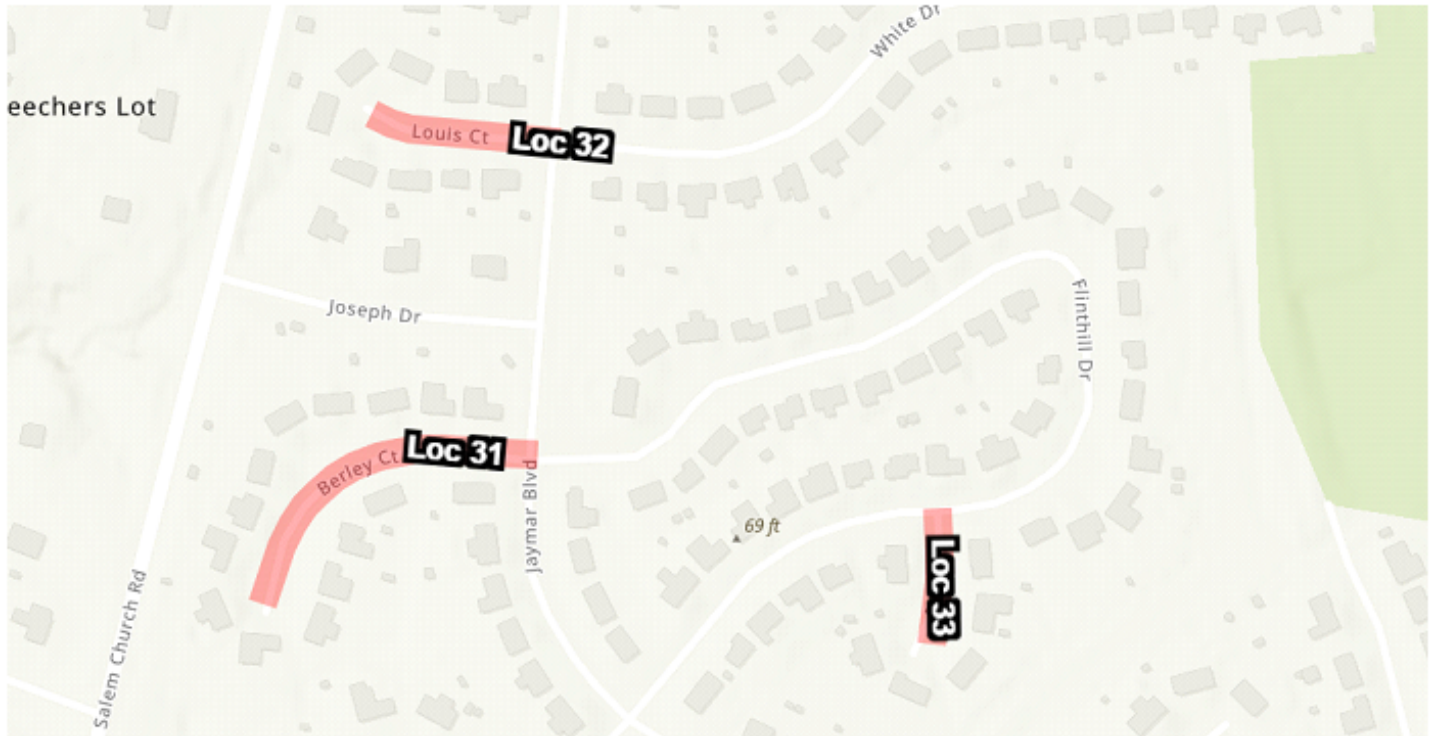

---

DEPARTMENT OF TRANSPORTATION

---

CONTRACT NUMBER- T202504906

(CAD) PAGE 14 OF 84

---

Contract is for various locations throughout New Castle County.

---

LOCATION MAP

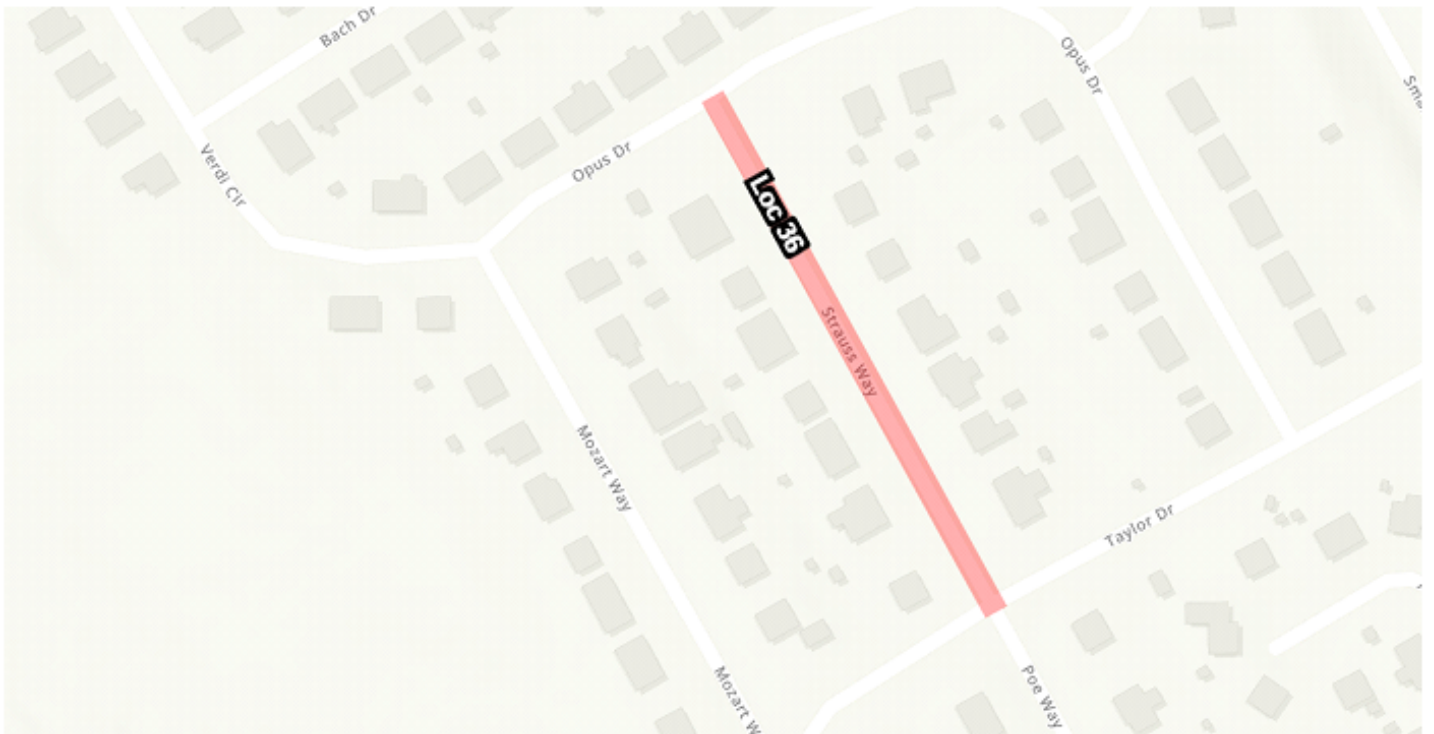
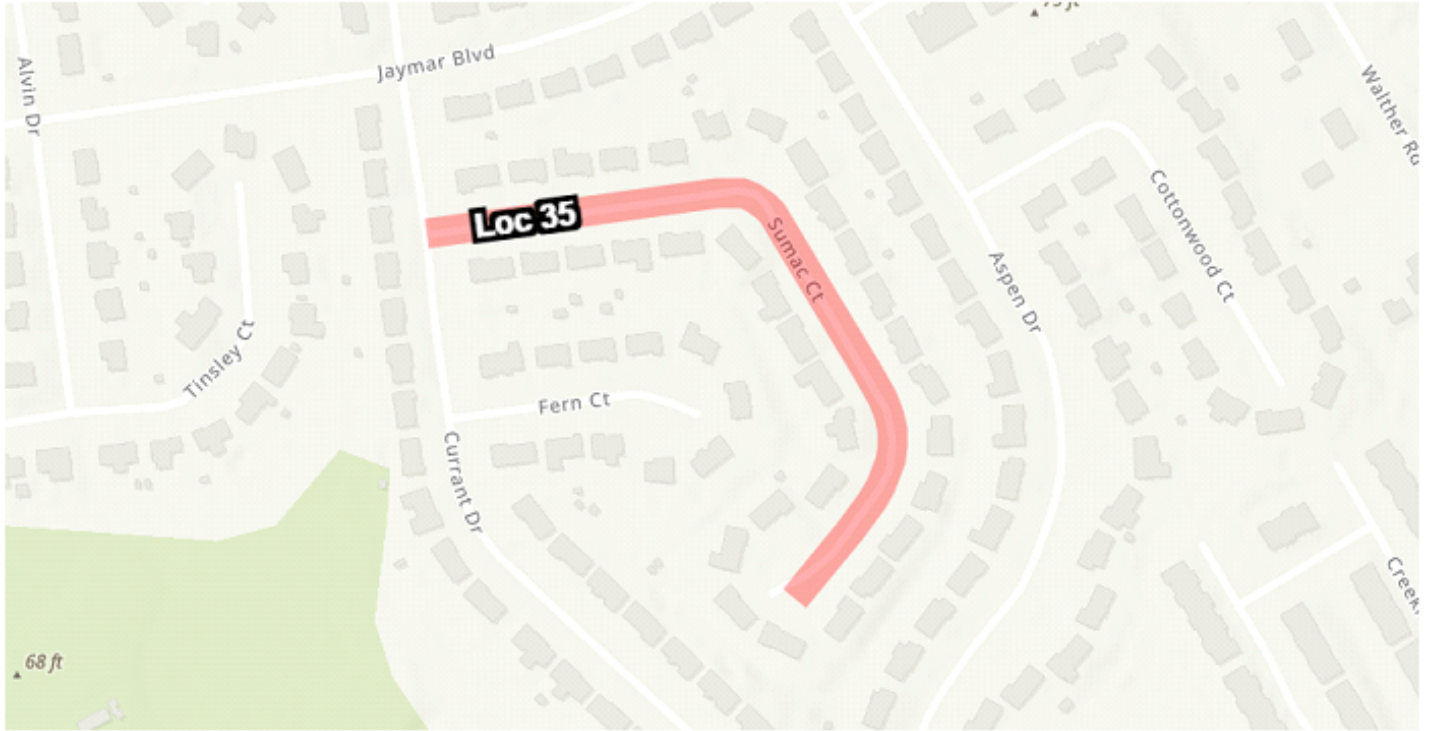

---

DEPARTMENT OF TRANSPORTATION

---

CONTRACT NUMBER- T202504906

(CAD) PAGE 15 OF 84

---

Contract is for various locations throughout New Castle County.

---

LOCATION MAP

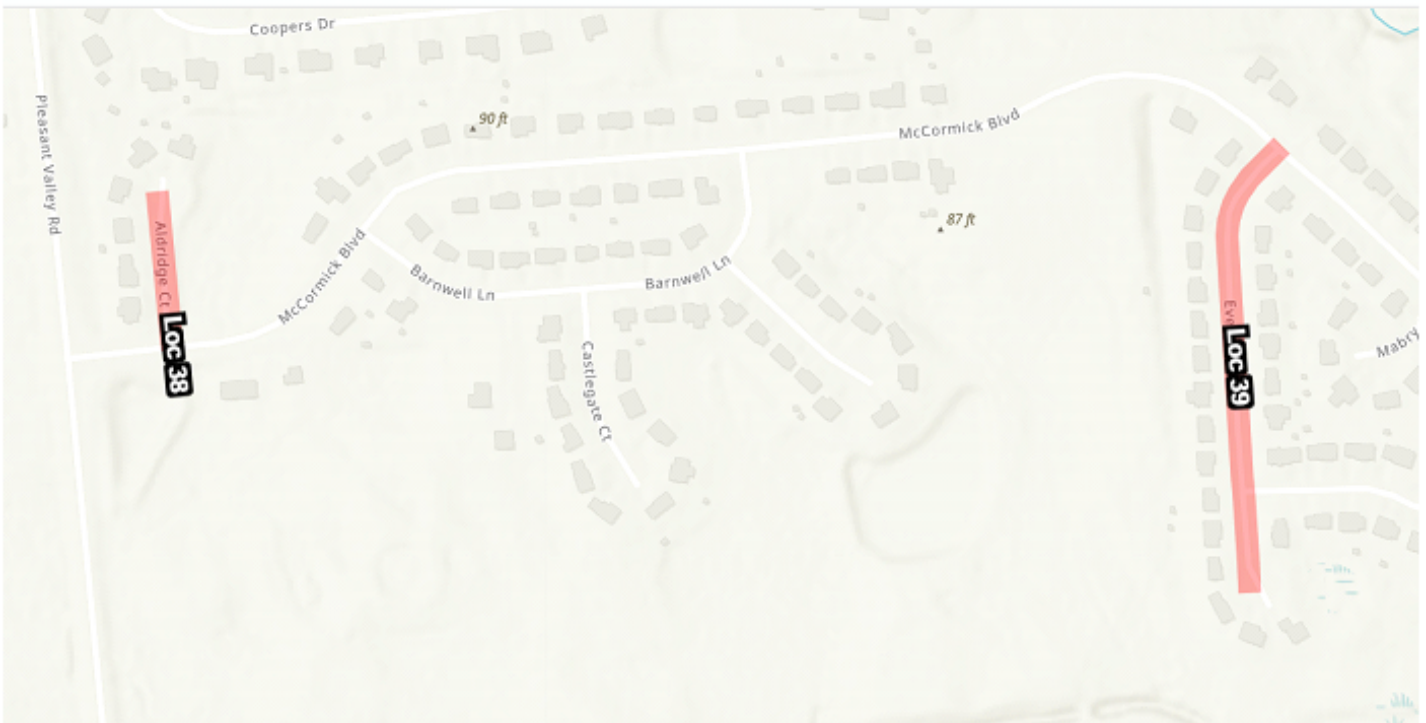
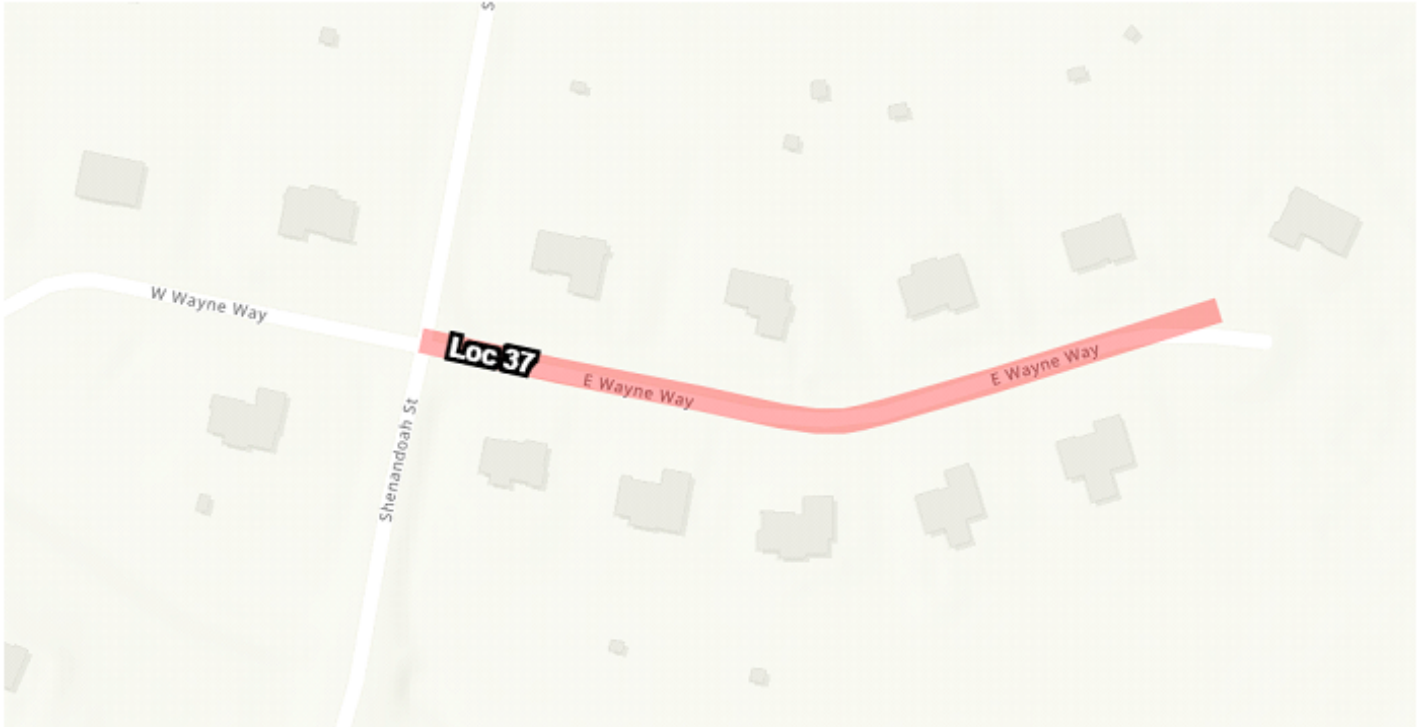

**GENERAL CONTRACT PLAN NOTES**

**SECTION 100**

1. THIS PROJECT IS TO BE CONSTRUCTED IN ACCORDANCE WITH THE DELAWARE DEPARTMENT OF TRANSPORTATION STANDARD SPECIFICATIONS FOR ROAD AND BRIDGE CONSTRUCTION DATED JANUARY 2024 AND THE DELAWARE DEPARTMENT OF TRANSPORTATION STANDARD CONSTRUCTION DETAILS DATED 2024, INCLUDING ALL REVISIONS UP TO THE DATE OF ADVERTISEMENT.

2. THE PURPOSE OF THIS CONTRACT IS TO MAKE GENERAL IMPROVEMENTS TO ROADS AND/OR STREETS WITHIN THE DISTRICT HEREIN SPECIFIED. DEPENDING ON FUND AVAILABILITY, THE DEPARTMENT RESERVES THE RIGHT TO ADD OR DELETE LOCATIONS AND/OR QUANTITIES FOR THIS CONTRACT. SUCH ADDITIONS OR DELETIONS SHALL NOT BE CAUSE FOR AN INCREASE OR DECREASE IN ANY CONTRACT UNIT BID PRICES. NO ITEM PRICES ARE TO BE RENEGOTIATED DUE TO EITHER AN INCREASE OR DECREASE IN QUANTITY USAGE RESULTING FROM SAID ADDITIONS OR DELETIONS.

3. THE CONTRACTOR SHALL PROVIDE WRITTEN NOTICE TO RESIDENTS AND BUSINESSES AT LEAST 48 HOURS, BUT NO MORE THAN 96 HOURS, PRIOR TO ALL PHASES OF CONTRACT WORK INCLUDING BUT NOT LIMITED TO: SAWCUTTING FOR P.C.C. OPERATIONS, P.C.C. REMOVAL AND REPLACEMENT, PAVEMENT MILLING, AND PAVING. THIS NOTICE SHALL BE GIVEN TO ALL RESIDENTS AND BUSINESSES WHOSE PROPERTY IS ADJACENT TO THE STREET ON WHICH WORK IS TO BE PERFORMED. FAILURE TO GIVE PROPER NOTICE WILL RESULT IN A SUSPENSION OF WORK REQUIRING NOTICE, UNTIL PROPER NOTICE IS PROVIDED. UPON COMPLETION OF DISTRIBUTING WRITTEN NOTICES, THE CONTRACTOR SHALL IMMEDIATELY NOTIFY THE ENGINEER.

4. LOCATION LISTINGS INDICATE GENERAL LIMITS OF CONSTRUCTION, MAJOR TYPES OF IMPROVEMENTS, AND ESTIMATED QUANTITIES. DURING THE BIDDING PERIOD, ANY QUESTIONS PERTAINING TO LOCATIONS SHALL BE DIRECTED TO THE CONTRACT ADMINISTRATOR. AFTER THE AWARD, SUCH QUESTIONS SHALL BE REFERRED TO THE APPROPRIATE DISTRICT ENGINEER OR HIS REPRESENTATIVE.

5. THIS CONTRACT WILL HAVE CLEAR "START BY" DATE AND TIME ALLOCATED FOR COMPLETION. FAILURE TO COMPLETE THE CONTRACT IN THE SPECIFIED TIME SHALL CONSTITUTE "FAILURE TO PURSUE THE WORK" AND SUBJECTS THE CONTRACTOR TO LIQUIDATED DAMAGES AS OUTLINED IN SUBSECTION 108.8 OF THE STANDARD SPECIFICATIONS.

6. THE CONTRACTOR SHALL SUBMIT THE REQUIRED COPIES OF A DETAILED PROGRESS SCHEDULE (PSC) AS OUTLINED IN STANDARD SPECIFICATION 108.4 PRIOR TO THE PRECONSTRUCTION MEETING. DETAILS SHALL INCLUDE A DESCRIPTION OF EACH WORK ACTIVITY, THE PLANNED DAYS OF WORK, MULTIPLE CREWS OR SHIFTS, AND SCHEDULED WORKING HOURS. DURING THE CONTRACT, THE CONTRACTOR SHALL SUBMIT TWO-WEEK (OR

---

**DEPARTMENT OF TRANSPORTATION**

---

**CONTRACT NUMBER- T202504906 CANAL  
SUBDIVISION PAVING, NEW CASTLE COUNTY VI, 2025**

**(CAD) PAGE 17 OF 84**

---

**GENERAL CONTRACT PLAN NOTES**

AS REQUIRED) "LOOK AHEAD" SCHEDULES TO THE AREA ENGINEER/ MANAGER NO LATER THAN NOON OF EACH THURSDAY. FAILURE TO COMPLY WILL RESULT IN A SUSPENSION OF ALL CONTRACT WORK WITH TIME CHARGES CONTINUING TO BE ASSESSED.

**ADDITIONAL WORK:**

7. THE DEPARTMENT RESERVES THE RIGHT TO INCREASE OR DECREASE THE QUANTITIES OF THE ITEMS SPECIFIED IN THIS CONTRACT. SUCH ADDITIONS SHALL NOT BE CAUSE FOR AN INCREASE OR DECREASE IN ANY CONTRACT UNIT BID PRICES AND/OR LUMP SUM ITEMS IF THE INCREASE IN QUANTITIES DOES NOT REQUIRE REMOBILZATON.

8. THE DEPARTMENT RESERVES THE RIGHT TO ADD LOCATONS TO THIS CONTRACT. SPECIFIC WORK WILL BE ASSIGNED BY THE DEPARTMENT VIA WORK ORDERS AND THE DEPARTMENT WILL MAKE EVERY ATTEMPT TO MINIMIZE THE DISTANCE BETWEEN SUCCESSIVE LOCATIONS. THE CONTRACTOR MAY SUBMIT A REQUEST FOR ADDITIONAL MOT AND MOBILIZATION IN CONJUNCTION WITH ADDED LOCATIONS. THIS REQUEST WILL BE CONSIDERED ON THE BASIS OF EACH ADDITIONAL LOCATION. THE REQUEST FOR INITIAL EXPENSE/MOBILIZATION SHALL NOT EXCEED THE AMOUNT OF THE BID PRICE FOR 763000, DIVIDED BY THE NUMBER OF ORIGINAL CONTRACT LOCATIONS. THE REQUEST FOR MOT SHALL NOT EXCEED THE AMOUNT OF THE BID PRICE FOR 801500, DIVIDED BY THE NUMBER OF ORIGINAL CONTRACT LOCATIONS. FOR OPEN END CONTRACTS WITHOUT ORIGINAL LOCATIONS, BID ITEMS 763544-763552 SHALL BE FULL COMPENSATION FOR MOBILIZATION AND MOT.

EACH WORK ORDER ISSUED WILL HAVE CLEAR "START BY" DATE AND TIME ALLOCATED TO COMPLETE SAID WORK ORDER. ONCE TIME (CALENDAR DAYS) HAS BEEN ASSIGNED TO A WORK ORDER AND ISSUED, THE CONTRACTOR HAS 2 BUSINESS DAYS, NOT INCLUDING THE DAY OF ISSUANCE, TO DISPUTE THE TIME QUANTITY AND PROVIDE ADDITIONAL BACKUP DOCUMENTATION FOR WHY THE TIME QUANTITY IS NOT SUFFICIENT. A DETAILED BREAKDOWN OF LABOR/MATERIALS/EQUIPMENT ALONG WITH THE CONTRACTORS TIME ESTIMATE WILL BE REQUIRED; THIS INFORMATION MUST BE RECEIVED BY THE DEPARTMENT BY THE END OF THE 2<sup>ND</sup> BUSINESS DAY OR THE DEPARMENT WILL CONSIDER THE CONTRACTOR IN AGREEMENT WITH THE TIME ESTIMATE. THE ENGINEER WILL EVALUATE ANY REQUEST FOR MODIFICATION TO THE TIME ESTIMATE AND AT THEIR SOLE DISCRETION DETERMINE IF ADDITIONAL TIME IS GRANTED. DISPUTING TIME QUANTITY DOES NOT CONSTITUTE A DELAY IN COMMENCEMENT OF A WORK ORDER. ISSUANCE OF EACH WORK ORDER CONSTITUTES THE NOTICE TO PROCEED WITH THE WORK DESCRIBED. FAILURE TO COMPLETE A WORK ORDER IN THE SPECIFIED TIME SHALL CONSTITUTE "FAILURE TO PURSUE THE WORK" AND SUBJECTS THE CONTRACTOR TO LIQUIDATED DAMAGES AS OUTLINED IN SUBSECTION 108. 9 OF THE STANDARD SPECIFICATIONS BASED ON THE TOTAL VALUE OF THAT PARTICULAR WORK ORDER.

**GENERAL CONTRACT PLAN NOTES**

UPON ISSUANCE OF EACH WORK ORDER, THE CONTRACTOR SHALL SUBMIT THE REQUIRED COPIES OF A DETAILED PROGRESS SCHEDULE AS OUTLINED IN STANDARD SPECIFICATION 108.4 WITHIN 5 CALENDAR DAYS OF THE ISSUANCE OF WORK ORDER. DURING THE CONTRACT, THE CONTRACTOR SHALL SUBMIT TWO-WEEK (OR AS REQUIRED) "LOOK AHEAD" SCHEDULES TO THE AREA ENGINEER NO LATER THAN NOON OF EACH THURSDAY. DETAILS SHALL INCLUDE A DESCRIPTION OF EACH WORK ACTIVITY, THE PLANNED DAYS OF WORK, MULTIPLE CREWS OR SHIFTS, AND SCHEDULED WORKING HOURS. FAILURE TO COMPLY WILL RESULT IN A SUSPENSION OF ALL CONTRACT WORK WITH TIME CHARGES CONTINUING TO BE ASSESSED. THE PROGRESS SCHEDULE MUST ALSO BE UPDATED AND SUBMITTED TO THE DEPARTMENT AS CHANGES OR DELAYS OCCUR IN THE CONTRACT.

**SECTION 400**

9. UNLESS SPECIFIED, OVERLAY WIDTHS SHALL MATCH EXISTING WIDTHS.

10. THE COST OF CLIPPING BACK THE EDGES OF THE ROADWAY, SHOULDERS, AND THE FIRST 3' OF UNPAVED DRIVEWAY ENTRANCES, PICKING UP AND DISPOSING OF WASTE AND EXCESS MATERIAL, AND CLEANING THE EXISTING PAVEMENT PRIOR TO AN OVERLAY SHALL BE INCIDENTAL TO SECTION 401XXX. PREPARING UNPAVED DRIVEWAY ENTRANCES BEYOND THE FIRST 3' SHALL BE PAID UNDER THE APPROPRIATE CONTRACT ITEMS: 202000 AND/OR 30100X.

11. ALL PAVING, INCLUDING TURN LANES AND INTERSECTIONS, IS TO BE COMPLETED CURB TO CURB WITHIN SEVEN (7) CALENDAR DAYS FROM THE TIME THE AREA WAS MILLED. THIS RESTRICTION APPLIES TO EACH DAYS PAVEMENT MILLING OPERATION, NOT AN ENTIRE PROJECT LOCATION. FAILURE TO COMPLY WILL RESULT IN A SUSPENSION OF ALL OTHER CONTRACT WORK WITH TIME CHARGES CONTINUING TO BE ASSESSED.

12. IN ADDITION TO ITEM 401506 SPEED HUMP BEING UTILIZED FOR NEW SPEED HUMPS, IT SHALL ALSO INCLUDE REMOVE AND REPLACE SPEED HUMPS. UNLESS NOTED OTHERWISE, SPEED HUMPS SHALL BE MEASURED AND REPLACED AT THE SAME HEIGHT PRIOR TO CONSTRUCTION BUT SHALL NOT EXCEED 4". ALL SIGNING AND STRIPING SHALL CONFORM TO THE LATEST EDITION OF THE DE MUTCD.

AT REMOVE AND REPLACE LOCATIONS, 401506 SHALL BE PAID AND THE REMOVAL SHALL BE INCIDENTAL TO THIS ITEM. SPEED HUMPS REMOVED AS PART OF THE MILLING/PAVING OPERATION, SCHEDULED TO BE PUT BACK, SHALL BE REPLACED WITHIN SEVEN (7) DAYS OF COMPLETION OF PAVING. FAILURE TO COMPLY WILL RESULT IN A SUSPENSION OF ALL OTHER CONTRACT WORK WITH TIME CHARGES CONTINUING TO BE ASSESSED. PAYMENT FOR THIS ITEM

**GENERAL CONTRACT PLAN NOTES**

SHALL INCLUDE PERMANENT STRIPING AND DELINEATOR POSTS. IF PERMANENT STRIPING CANNOT BE PLACED THE SAME DAY AS THE SPEED HUMP PLACEMENT, TEMPORARY STRIPING SHALL BE APPLIED THE SAME DAY.

13. PAVING WILL INCLUDE INTERSECTING STREETS FROM P.C. TO P.C.: MILLING AND PAVING OF INTERSECTING STREETS WILL NOT BE CONSIDERED FOR ENTRANCE, DRIVEWAY AND INTERSECTING STREET PAVEMENT SURCHARGE, NOR WILL DRIVEWAYS AND ENTRANCES.

14. FOR BITUMINOUS CONCRETE PATCH:

- FOR DRIVEWAY APRONS (BEHIND CURB) PLACE 2 LIFTS OF 2" BITUMINOUS CONCRETE TYPE C.
- FOR FINISHED PATCHES IN FRONT OF CURB, PLACE 2 LIFTS OF 2" BITUMINOUS CONCRETE TYPE C.
- FOR TEMPORARY PATCHES IN FRONT OF CURB, PLACE 2 LIFTS OF 2" OF BITUMINOUS CONCRETE TYPE C OR AS DIRECTED BY THE AREA ENGINEER.
- THE ENGINEER MAY CHANGE TYPE OF BITUMINOUS CONCRETE AND DEPTHS AT THEIR DISCRETION.

**SECTION 500**

15. ITEM 501001 PCC PAVEMENT, 8" IS DESIGNATED FOR NOW-DEFUNCT ITEM 701004 PCC VALLEY GUTTER-8". WHEN REPLACING VALLEY GUTTERS, PLEASE REFER TO CONTRACT PLAN DETAILS. DOWEL BARS, WIRE MESH REINFORCEMENT, BITUMINOUS SEAL, AND EXPANSION, PCC SAWCUTS, AND GABC UNDER THE PCC ARE INCIDENTAL TO VALLEY GUTTER ITEM (501001).

**SECTION 600**

16. DRAINAGE INLET GRATES ADJACENT TO THE ROAD, WITHIN THE PROJECT LIMITS, WHICH ARE NOT TYPE 1 SHALL BE REPLACED WITHIN 7 DAYS OF PAVING. THE NEED FOR ANY GRATE MODIFICATIONS OR FOR NEW FRAMES SHALL BE DETERMINED BY THE ENGINEER. ALL REPLACED GRATES/ FRAMES SHALL BE DELIVERED TO THE CANAL DISTRICT MAINTENANCE YARD, OR AS DIRECTED WITH THE COST OF DELIVERY INCIDENTAL TO 602100/602101, REPLACING DRAINAGE INLETS GRATES/FRAMES. FINAL PAYMENT FOR REPLACED GRATES/ FRAMES SHALL NOT BE MADE UNTIL RECEIPT OF DELIVERED MATERIALS IS PRODUCED, SIGNED BY A DELDOT MAINTENANCE YARD SUPERVISOR.

17. CATCH BASINS WITH A MANHOLE SHALL BE CONVERTED TO A STANDARD CATCH BASIN AT THE DISCRETION OF THE ENGINEER. A 6" COVERSLAB WITH REBAR 6-8" ON CENTER AND

**GENERAL CONTRACT PLAN NOTES**

MINIMUM OF 6" OF TOPSOIL ON TOP SHALL REPLACE MANHOLE. PAYMENT FOR ADDITIONAL WORK SHALL BE PAID AN ADDITIONAL QUANTITY OF 0.5 THE BID AMOUNT FOR ITEM 602130 OR 602131.

18. WHEN ENCOUNTERING DELDOT STORMWATER MANHOLES WITHIN LIMITS OF PAVING, THOSE MANHOLES WILL BE ADJUSTED AND UPDATED AT THE DISCRETION OF THE ENGINEER. ITEMS 602102/602103 SHALL BE FULL COMPENSATION (FURNISH AND INSTALLING) THE NEW LIDS AND FRAMES.

19. WHEN ENCOUNTERING NEW CASTLE COUNTY SANITARY MANHOLES WITHIN THE LIMITS OF PAVING, THOSE MANHOLES WILL BE ADJUSTED AND UPDATED AT THE DISCRETION OF THE ENGINEER. THE LIDS AND FRAMES ARE PROVIDED BY NEW CASTLE COUNTY AT NO COST TO THE CONTRACTOR. OBTAINING, STORING, DELIVERING, AND PLACING THESE NEW LIDS AND FRAMES SHALL BE INCIDENTAL TO THE ADJUSTMENT ITEM 602132.

ANY ADJUSTMENTS TO THE AFOREMENTIONED MUNICIPALLY OWNED FACILITIES SHALL BE DONE IN ACCORDANCE WITH THE RESPECTIVE AGENCIES STANDARD SPECIFICATIONS, AS CONSTRUCTION WARRANTS.

- THE COUNTY REQUIRES A FULL BEARING OF BRICK BENEATH ALL ADJUSTED SANITARY MANHOLE CASTINGS.
- THE COUNTY ACCEPTS THE USE OF 1-1/2" TO 3" PRECAST P.C.C. RINGS FOR THEIR MANHOLE ADJUSTMENTS, UPON APPROVAL OF THE CONTRACTOR'S SOURCE OF MATERIALS SUBMISSION.

**SECTION 700**

20. BUTT JOINTS SHALL BE CONSTRUCTED AT ALL INTERSECTING BITUMINOUS CONCRETE ROADS AND ANY OTHER LOCATIONS AS DIRECTED BY THE ENGINEER. BUTT JOINTS AT RAILROAD CROSSINGS AND AT BRIDGE OR DRAINAGE STRUCTURES NOT TO BE RESURFACED SHALL BE AS PER THE INCLUDED PLAN DETAIL. BUTT JOINTS CUT PRIOR TO THE DAY OF PAVEMENT OVERLAY SHALL BE RAMPED WITH BITUMINOUS CONCRETE TRM, IN MILLING AREAS, INCIDENTAL TO THE ITEM 762004 BUTT JOINT. ONLY BITUMINOUS CONCRETE WILL BE ALLOWED FOR THIS PURPOSE. BUTT JOINTS IN FULL MILL AREAS SHALL BE INCIDENTAL TO THE PAVEMENT MILLING ITEM (760010). SAWCUTS FOR BUTT JOINTS SHALL BE INCIDENTAL TO THE BUTT JOINT ITEM. ALL BITUMINOUS CONCRETE TRM SHALL BE REMOVED PRIOR TO THE PAVING OPERATION.

21. THE USE OF MILLINGS AND GABC IN THE TRAVEL WAY, TEMPORARY TRAVEL WAY, HIGH VOLUME ENTRANCES AND ACCESS RAMP FOR THE PURPOSE OF PROVIDING A TEMPORARY ROADWAY SURFACE, POTHOLE REPAIR, TAPERED EDGE FOR UTILITIES, BUTT JOINTS, AND LONGITUDINAL DROP-OFFS (MILLING AND PAVING OPERATIONS) IS PROHIBITED UNLESS IT IS OTHERWISE DESIGNATED TO BE USED IN THE CONTRACT PLANS. USE COLD PATCH, BITUMINOUS CONCRETE, BITUMINOUS CONCRETE WEDGE, OR TAPER MILL, AS NOTED IN THE CONTRACT

---

DEPARTMENT OF TRANSPORTATION

---

CONTRACT NUMBER- T202504906 CANAL  
SUBDIVISION PAVING, NEW CASTLE COUNTY VI, 2025

(CAD) PAGE 21 OF 84

---

**GENERAL CONTRACT PLAN NOTES**

DOCUMENTS OR APPROVED BY THE ENGINEER. PAYMENT FOR COLD PATCH, BITUMINOUS CONCRETE, OR BITUMINOUS CONCRETE WEDGE SHALL BE INCIDENTAL TO THE BITUMINOUS CONCRETE MILLING ITEM.

MILLINGS OR GABC SHALL BE USED AT THE FOLLOWING LOCATIONS WHERE ACCESS TO A BUSINESS RESIDENCE, OR EDGE DROP OFF NEEDS TO BE MAINTAINED UNLESS OTHERWISE NOTED IN THE PLANS OR DIRECTED BY THE ENGINEER TO USE BITUMINOUS CONCRETE OR COLD PATCH. ALL MILLING AND GABC WILL BE ROLLED AND COMPACTED TO HELP PREVENT THE MATERIAL FROM UNRAVELING.

- A. DRIVEWAYS
- B. ENTRANCES
- C. LOW VOLUME ACCESS RAMPS (IDENTIFIED IN THE CONTRACT DOCUMENTS)
- D. EDGE DROP-OFFS ADJACENT TO LIVE ROADWAY (LANE, SHOULDER, OR TURN LANE) AND THE PROPOSED ROAD CONSTRUCTION
- E. EDGE OF ROADWAY DROP-OFF

GRADING AND MAINTAINING BASE COURSE THAT IS BEING USED FOR ROADWAY WEDGE/FILLET BETWEEN TRAVEL LANES AND PAVEMENT BOX, EDGE OF TRAVEL WAY, DRIVEWAY OR ENTRANCE ACCESS SHALL BE INCIDENTAL TO ITEM NO. 801XXX - MAINTENANCE OF TRAFFIC. THE BASE COURSE MATERIAL SHALL BE PLACED AT NO GREATER THAN THE SLOPE SPECIFIED IN TABLE 6G-1 AND SHALL BE COMPACTED. EXCESS BASE COURSE MATERIAL SHALL BE PUSHED AHEAD AND USED IN THE NEXT SEGMENT AND SHALL BE INCIDENTAL TO THE PARTICULAR BASE COURSE PAY ITEM. NO SEPARATE PAYMENT SHALL BE MADE FOR MILLINGS OR GABC TEMPORARY ROADWAY MATERIAL (TRM) USED TO PROTECT EDGE DROP-OFFS, UNLESS THE MATERIAL IS EVENTUALLY UTILIZED AS PART OF A PERMANENT ROADWAY AT WHICH TIME THE MATERIAL WOULD BE PAID FOR UNDER THE RESPECTIVE CONTRACT MATERIAL ITEM. VERTICAL DIFFERENCES SHALL BE CORRECTED IN ACCORDANCE WITH TABLE 6G-1 OF THE DELAWARE MUTCD.

22. AFTER PAVEMENT MILLING, ALL TRANSVERSED VERTICAL DIFFERENCES, RAISED EDGES OF MANHOLES, DRAINAGE INLETS, WATER VALVE BOXES, ETC. SHALL BE RAMPED WITH BITUMINOUS CONCRETE TRM AT A 20:1 OR FLATTER SLOPE PRIOR TO OPENING THE ROADWAY TO TRAFFIC AND SHALL BE INCIDENTAL TO PAVEMENT MILLING. PAVEMENT MILLINGS OR COLD PATCH MATERIAL WILL NOT BE ALLOWED FOR THIS PURPOSE.

ALL ADJUSTMENTS SHALL BE MADE NOT MORE THAN SEVEN (7) CALENDAR DAYS PRIOR TO THE PLACEMENT OF THE FINAL COURSE OF BITUMINOUS CONCRETE, UNLESS DIRECTED BY THE

**GENERAL CONTRACT PLAN NOTES**

ENGINEER. FAILURE TO COMPLY WILL RESULT IN A SUSPENSION OF ALL OTHER CONTRACT WORK WITH TIME CHARGES CONTINUING TO BE ASSESSED.

ALL BITUMINOUS CONCRETE TRM SHALL BE REMOVED PRIOR TO THE PAVING OPERATIONS. IF THE CONTRACTOR ELECTS TO ADJUST MANHOLES, DRAINAGE INLETS AND WATER VALVES AFTER THE FINAL COURSE OF PAVING, THIS WORK MUST BE COMPLETED WITHIN SEVEN (7) CALENDAR DAYS OF THE FINAL COURSE OF BITUMINOUS CONCRETE. FAILURE TO COMPLY WILL RESULT IN A SUSPENSION OF ALL OTHER CONTRACT WORK WITH TIME CHARGES CONTINUING TO BE ASSESSED.

23. THE CONTRACTOR SHALL TAKE CARE IN REMOVING PAVEMENT AROUND UTILITIES, BUTT JOINTS, CURBS, ETC. SO THAT EXISTING PAVEMENT BEYOND THE SPECIFIED DEPTHS IS NOT DAMAGED. ANY DAMAGE CAUSED BY THE CONTRACTOR'S OPERATIONS MAY RESULT IN PLACING LEVELING COURSES AT THE CONTRACTOR'S EXPENSE. THE REMOVAL AND CLEAN UP OF THE HOT MIX RESIDUE WEDGE REMAINING AFTER MILLING OPERATIONS SHALL BE INCIDENTAL TO THE MILLING ITEM. THE REMOVAL OF EXISTING RAISED PAVEMENT MARKERS (RPM'S) SHALL BE INCIDENTAL TO THE APPLICABLE MILLING AND/OR RECLAMATION ITEMS.

24. TAPER MILLING IS INTENDED FOR MILLING IN THE AREA OF FIXED STRUCTURES (I.E. CURBS, MANHOLES, ETC.) THE MILLED DEPTH AT THE STRUCTURE SHALL BE THE DEPTH OF THE PROPOSED OVERLAY AND 0" AT A DISTANCE OF +/- 6 1/2 FEET FROM THE STRUCTURE. THE COMPUTED DEPTH FOR PAYMENT PURPOSES IS THE AVERAGE OF THE TWO DEPTHS.

25. ON THIS CONTRACT FULL MILL AREAS WILL UTILIZE ITEM 760010 PAVEMENT MILLING, BITUMINUOUS CONCRETE PAVEMENT (SY-IN). UNLESS OTHERWISE NOTED, ALL MILLING LOCATIONS ARE EXPECTED TO BE MILLED AT A 2" DEPTH. FOR AVERAGE MILLING DEPTHS OF 0.5" TO AN AVERAGE MILLING DEPTH OF 2.25", THE FULL MILL AREAS WILL BE PAID AT AN AVERAGE 2".

26. MILLING OF BITUMINOUS PAVEMENT IN PREPARTION FOR OVERLAY IS TO INCLUDE MILLING EXISTING CONCRETE PATCHES AND/OR COMPOSITE PAVING AND SHOULD BE CONSIDERED INCIDENTAL TO ITEM 760010, PAVEMENT MILLING, BITUMINOUS CONCRETE PAVEMENT.

27. ALL MILLED MATERIAL SHALL REMAIN THE PROPERTY OF THE CONTRACTOR UNLESS OTHERWISE STATED.

28. AT LOCATIONS THAT HAVE PCC REPLACEMENT, PAVING MUST BE COMPLETED WITHIN 90

**GENERAL CONTRACT PLAN NOTES**

CALENDAR DAYS FROM THE START OF THE PCC REPLACEMENT. BETWEEN OCTOBER 15TH AND NOVEMBER 30<sup>TH</sup>, PAVING MUST BE COMPLETED WITHIN 30 CALENDAR DAYS FROM THE START OF THE PCC REPLACEMENT. FAILURE TO COMPLY WILL RESULT IN A SUSPENSION OF ALL OTHER CONTRACT WORK WITH TIME CHARGES CONTINUING TO BE ASSESSED.

29. UPRIGHT PCC CURB UTILIZED FOR GRADE RETENTION 8" OR HIGHER WILL BE PAID AS 701013, TYPE 1-8 CURB.

30. EXCAVATION UP TO 2' IN FRONT OF CURB, ADA FACILITIES, AND DRAINAGE INLETS WILL BE INCIDENTAL TO THE CORRESPONDING ITEMS (701XXX, 705XXX, AND 602XXX). HOT MIX PLACED IN FRONT OF CURB WILL BE PAID UNDER ITEM 401XXX. USE OF CONCRETE AS FILL IN FRONT OF CURB WILL NOT BE ACCEPTED UNLESS DIRECTED BY THE ENGINEER. AT EACH LOCATION, BACKFILLING SHALL BE PERFORMED IMMEDIATELY UPON REMOVAL OF FORMS FOR CURB OR SIDEWALK. TOPSOIL, SEEDING, SEALING OF VALLEY GUTTERS, REMOVING OF FORMS, AND PARGING OF CATCH BASINS, SHALL BE COMPLETED WITHIN SEVEN (7) CALENDAR DAYS OF COMPLETION OF THE ITEM OF WORK. ITEM 908001, TOPSOIL, SHALL BE USED AS BACKFILL MATERIAL BEHIND CURB AND AROUND SIDEWALK OR/AS DIRECTED BY THE ENGINEER. TOPSOIL SHALL BE SCREENED/SIFTED SO AS NO MATERIAL GREATER THAN .5" SHOULD BE PRESENT IN MATERIAL USED FOR BACKFILL. EXCAVATED MATERIAL, NOT NEEDED ON THE PROJECT, SHALL BE REMOVED FROM THE CONTRACT AT THE CONTRACTORS EXPENSE. FAILURE TO COMPLY WILL RESULT IN A SUSPENSION OF ALL OTHER CONTRACT WORK WITH THE CHARGES CONTINUING TO BE ASSESSED.

31. AS DIRECTED BY THE ENGINEER, THE CONTRACTOR SHALL PARTIALLY SAW AND FILL EXISTING CRACKED CURB AND/OR SIDEWALK WITH AN APPROVED SEALER. THIS WORK WILL BE INCIDENTAL TO ITEM 762001 SAWCUT - CONCRETE FULL DEPTH.

32. PERTAINING TO PCC CURB REMOVAL & PATCHING, SAWCUTTING IS TO BE PERFORMED PRIOR TO THE REMOVAL OF BITUMINOUS CONCRETE UNLESS APPROVAL IS GIVEN BY THE ENGINEERS REPRESENTATIVE.

33. BEFORE THE START OF A DAY'S PAVEMENT MILLING OR PAVING OPERATIONS AND WHERE THERE IS EXISTING STRIPING, THE CONTRACTOR SHALL BE REQUIRED TO PROVIDE PROOF THAT SUFFICIENT APPROVED STRIPING MATERIALS ARE ON HAND TO ENSURE STRIPING IS COMPLETE BEFORE TRAFFIC IS RETURNED TO THE ROADWAY.

34. LANE CLOSURES ON 3-DIGIT MAINTENANCE ROADS ARE PERMITTED ONLY BETWEEN THE HOURS OF 9:00 AM AND 3:00 PM, MONDAY - FRIDAY. ANY VARIANCE SHALL REQUIRE DISTRICT SAFETY OFFICERS APPROVAL.

---

DEPARTMENT OF TRANSPORTATION

---

CONTRACT NUMBER- T202504906 CANAL  
SUBDIVISION PAVING, NEW CASTLE COUNTY VI, 2025

(CAD) PAGE 24 OF 84

---

**GENERAL CONTRACT PLAN NOTES**

35. ITEM 710370 STEEL CASING PIPE-4" IS DESIGNATED FOR NOW-DEFUNCT ITEM 718000 ROOF DRAIN. WHEN REPLACING OR EXTENDING ROOF DRAINS, SUMP PUMP DRAINS, ETC. FROM RIGHT-OF-WAY TO CURBLINE, ITEM 710370 WILL BE UTILIZED REGARDLESS OF PIPE MATERIAL OR SIZE.

36. GAS VALVE, MONUMENT BOX, AND LAMPHOLE ADJUSTMENTS WILL BE PAID AS 710002, WATER VALVE ADJUSTMENTS.

37. REMOVAL OF ANY UNSUITABLE MATERIALS INCLUDING ROOTS AND VEGETATIVE MATTER DISCOVERED WITHIN OR DIRECTLY BELOW THE TEMPLATE OF PCC / GRANITE CURB, PEDESTRIAN FACILITIES, AND/OR PCC / BRICK SIDEWALKS SHALL BE INCIDENTAL TO THE CORRESPONDING ITEM.

38. TRASH, RUBBISH, DEBRIS, OR BRUSH THAT HAMPERS REPAIR/MAINTENANCE WORK IN THIS CONTRACT (AS DETERMINED BY THE ENGINEER), SHALL BE REMOVED WITHIN THE PROJECT LIMITS AND SHALL BE INCIDENTAL TO PAY ITEM 763000 (INITIAL EXPENSE/DEMobilIZATION).

39. CLEARING AND GRUBBING INCLUDES OBTAINING WIDTH AND HEIGHT REQUIREMENTS FOR PAR AND CLEARING OF SIGHT DISTANCE (INCLUDING EXISTING FACILITIES AND SIGNS). CLEARING AND GRUBBING OF TREES, SHRUBS AND OTHER VEGETATION LESS THAN 6" IN DIAMETER SHALL BE INCIDENTAL TO ITEM 763000 (INITIAL EXPENSE/DEMobilIZATION).

40. GRASS AND SOIL AREAS WITHIN THE STATE RIGHT-OF-WAY AND ADJACENT PRIVATE PROPERTY THAT HAS BEEN DAMAGED DURING CONTRACT OPERATIONS SHALL BE RESTORED WITH TOPSOIL, SEED AND MULCH AT THE CONTRACTOR'S EXPENSE. WORK SHALL BE EXECUTED IN ACCORDANCE WITH THE REQUIREMENTS FOR ITEM 908001 (TOPSOIL), ITEM 908016 (PERMANENT GRASS SEEDING SUBDIVISION), AND ITEM 908020 (EROSION CONTROL BLANKET MULCH). REPAIRS MUST BE COMPLETED WITHIN SEVEN (7) CALENDAR DAYS OF NOTIFICATION. FAILURE TO COMPLY WILL RESULT IN A SUSPENSION OF ALL OTHER CONTRACT WORK WITH TIME CHARGES CONTINUING TO BE ASSESSED.

**SECTION 800**

41. MESSAGE BOARDS SHALL BE PLACED 10 DAYS IN ADVANCE OF THE WORK AND SHALL REMAIN IN PLACE FOR 5 DAYS AFTER THE START OF WORK. LOCATIONS OF MESSAGE BOARDS AND MESSAGES DISPLAYED SHALL BE REVIEWED AND APPROVED BY THE DISTRICT SAFETY OFFICER.

42. AT EACH LOCATION, THE CONTRACTOR SHALL NOTE ALL EXISTING PAVEMENT MARKINGS AND SUBMIT A DRAWING WHICH DEPICTS THE STRIPING PATTERN TO THE DEPARTMENT PRIOR TO THE START OF ANY WORK AT THE LOCATION.

---

**DEPARTMENT OF TRANSPORTATION**

---

**CONTRACT NUMBER- T202504906 CANAL  
SUBDIVISION PAVING, NEW CASTLE COUNTY VI, 2025**

**(CAD) PAGE 25 OF 84**

---

**GENERAL CONTRACT PLAN NOTES**

AT THE END OF EACH DAY'S OPERATION AND BEFORE TRAFFIC IS RETURNED TO UNRESTRICTED ROADWAY USE, TEMPORARY MARKINGS SHALL BE UTILIZED AT LOCATIONS THAT REQUIRE PERMANENT MARKING. TEMPORARY PAVEMENT STRIPING MUST MATCH PERMANENT PAVEMENT STRIPING IN ALL REGARDS.

TEMPORARY PAVEMENT MARKINGS SHALL BE PAID AT THE APPLICABLE CONTRACT UNIT PRICE. THE CONTRACTOR IS RESPONSIBLE FOR MAINTAINING THE TEMPORARY MARKINGS IN GOOD CONDITION SUCH THAT THE PAVEMENT IS PROPERLY DELINEATED AT ALL TIMES. ANY REFRESHING OF THE TEMPORARY MARKINGS WILL BE AT THE CONTRACTOR'S EXPENSE.

FINAL PAVEMENT MARKINGS SHALL CONFORM TO ALL EXISTING PATTERNS AND SHALL BE PLACED WITHIN FIVE (5) CALENDER DAYS (MAXIMUM) AFTER PLACEMENT OF THE FINAL COURSE OF BITUMINOUS CONCRETE. IF THE CONTRACTOR FAILS TO DOCUMENT THE EXISTING PAVEMENT MARKINGS IN AN ACCEPTABLE MANNER, HE SHALL BE REQUIRED TO PROVIDE AT HIS OWN EXPENSE, A NEW PAVEMENT MARKING PLAN SIGNED AND SEALED BY A PROFESSIONAL ENGINEER REGISTERED IN THE STATE OF DELAWARE.

ANY ERRONEOUS MARKING WILL NOT BE PAID FOR AND SHALL BE CORRECTED IMMEDIATELY AT THE CONTRACTOR'S EXPENSE. ERRONEOUS MARKINGS OR SHADOWS THAT EXCEED ONE (1) INCH IN WIDTH SHALL BE REMOVED BY EITHER SAND OR WATER BLASTING. NO OTHER REMOVAL METHODS WILL BE ALLOWED. A FLAT BLACK PAINT OR DRIVEWAY SEALER SHALL BE APPLIED IN THE AREA OF THE REMOVED MARKING TO MASK THE REPAIR. ANY DAMAGE TO THE PAVEMENT CAUSED BY REMOVAL OF ERRONEOUS MARKINGS SHALL BE REPAIRED / REPLACED TO THE SATISFACTION OF THE ENGINEER. FAILURE TO COMPLY WILL RESULT IN SUSPENSION OF ALL OTHER CONTRACT WORK WITH TIME CHARGES CONTINUING TO BE ASSESSED.

43. THE CONTRACTOR, WITH THE ENGINEER, SHALL INVENTORY ALL SIGNS ON ALL ROADS SUBJECT TO IMPROVEMENTS. NECESSARY SIGNS SHALL BE MAINTAINED IN OPERATION DURING CONSTRUCTION AND ANY OTHER SIGNS SHALL BE PROPERLY STORED WITH THE CONTRACTOR, WHO SHALL BE RESPONSIBLE FOR LOSS OR DAMAGE. IMMEDIATELY PRIOR TO FINAL INSPECTION, THE CONTRACTOR AND ENGINEER SHALL AGAIN INVENTORY THE TRAFFIC SIGNS AND ACCOUNT FOR ANY LOST OR DAMAGED SIGNS. LOST OR DAMAGED SIGNS, AT THE DISCRETION OF THE ENGINEER SHALL BE REPLACED IN KIND AT THE CONTRACTOR'S EXPENSE.

44. REGULATORY SIGNS REMOVED MUST BE REINSTALLED THE SAME DAY. IN ABSENCE OF A

---

**DEPARTMENT OF TRANSPORTATION**

---

**CONTRACT NUMBER- T202504906 CANAL  
SUBDIVISION PAVING, NEW CASTLE COUNTY VI, 2025**

**(CAD) PAGE 26 OF 84**

---

**GENERAL CONTRACT PLAN NOTES**

SIGN SCHEDULE, INSTALLATION OR REMOVAL OF TRAFFIC SIGN(S) AND SIGN POST(S) WILL BE PAID AS 819018. THIS ITEM WILL BE PAID ONE TIME PER POST AFTER FINAL INSTALLATION.

45. A FORMAL DETOUR WILL NOT BE NECESSARY ON THIS CONTRACT. THE CONTRACTOR MUST MAINTAIN LOCAL TRAFFIC WITHIN THE PROJECT LIMITS UTILIZING FLAGGERS. MAINTENANCE OF TRAFFIC DURING LANE CLOSURES AND/OR LANE SHIFTS SHALL CONFORM TO TYPICAL APPLICATIONS OF THE DELAWARE MUTCD. ANY VARIANCE SHALL REQUIRE DISTRICT SAFETY OFFICERS APPROVAL.

46. BEFORE WORK IS DONE AT ANY LOCATION, THE APPROPRIATE DISTRICT SAFETY OFFICER MUST APPROVE THE MOT FOR THAT LOCATION TWO WEEKS IN ADVANCE. ANY ANTICIPATED IMPACT TO TRAFFIC SIGNALS MUST BE REVIEWED BY THE DELDOT TRAFFIC SECTION PRIOR TO CONSTRUCTION. THEY CAN BE CONTACTED AT 302-659-4061.

47. THE CONTRACTOR SHALL SUBMIT A TRAFFIC CONTROL PLAN, INCLUDING PEDESTRIAN AND BICYCLE FACILITIES, AS WELL AS THE NECESSARY NCHRP 350, THE MANUAL FOR ASSESSING SAFETY HARDWARE (MASH) CERTIFICATIONS, OR DELDOTS APPROVED PRODUCTS LIST (APL) FOR ALL DEVICES THAT WILL BE UTILIZED, FOR EACH LOCATION BEFORE THE START OF THE PRE-CONSTRUCTION MEETING. WRITTEN APPROVAL MUST BE RECEIVED BEFORE THE START OF WORK AT EACH AND EVERY LOCATION.

48. ALL TRAFFIC CONTROL DEVICES SHALL BE IN NEW OR REFURBISHED CONDITION AND SHALL BE IN COMPLIANCE WITH THE NCHRP 350, THE MANUAL FOR ASSESSING SAFETY HARDWARE (MASH) CERTIFICATIONS, OR DELDOTS APPROVED PRODUCTS LIST (APL). THE DEVICES SHALL BE APPROVED BY THE SAFETY SECTION PRIOR TO USE AND SHALL BE MAINTAINED IN GOOD CONDITION FOR THE DURATION OF THE CONTRACT.

49. ALL WORK SHALL BE PERFORMED IN A MANNER THAT WILL REASONABLY PROVIDE THE LEAST PRACTICABLE OBSTRUCTION TO ALL ROAD USERS, INCLUDING VEHICULAR, PEDESTRIAN AND BICYCLE TRAFFIC, AND SHALL CONFORM TO THE REQUIREMENTS OF THE 2011 DELAWARE MANUAL ON UNIFORM TRAFFIC CONTROL DEVICES, PART 6, INCLUDING ALL REVISIONS UP TO THE DATE OF ADVERTISEMENT FOR BIDS.

50. CURB RAMP AND/OR SIDEWALK CONSTRUCTION (NOT INCLUDING MEDIAN ISLANDS) SHALL BE COMPLETED DURING A SINGLE OPERATION. THE RAMP/SIDEWALK SHALL BE REMOVED AND PLACED BACK THE SAME NIGHT/DAY AND OPEN TO PEDESTRIAN TRAFFIC THE FOLLOWING DAY. THE USE OF A MONOLITHIC POUR SHALL BE PERMITTED WITH A BOND BREAKER TO BE PLACED AT THE BACK OF THE CURB AND EDGE OF SIDEWALK. IF THE CURB RAMP/SIDEWALK CANNOT BE COMPLETED IN A SINGLE OPERATION THE EXCAVATED AREA MUST BE TEMPORARILY BACKFILLED TO GRADE WITH COMPACTED MILLING MATERIAL ONLY. THIS TEMPORARY MATERIAL WILL BE INCIDENTAL TO THE CURB RAMP ITEM. THE DRESSING UP OF THE AREA BEING PAID AS A CURB RAMP WITH TOPSOIL AND SEED WILL BE PAID AT CONTRACT UNIT

---

**DEPARTMENT OF TRANSPORTATION**

---

**CONTRACT NUMBER- T202504906 CANAL  
SUBDIVISION PAVING, NEW CASTLE COUNTY VI, 2025**

**(CAD) PAGE 27 OF 84**

---

**GENERAL CONTRACT PLAN NOTES**

PRICES. THE CONTRACTOR SHALL MAINTAIN ACCESS TO AND ALONG PEDESTRIAN FACILITIES AT ALL TIMES DURING CONSTRUCTION. EARTH, STONE AND GRAVEL SURFACES ARE NOT ACCEPTABLE FOR PROVIDING PEDESTRIAN ACCESS. IF CURB RAMP CANNOT BE COMPLETED IN A SINGLE OPERATION AND PEDESTRIAN ROUTES ARE CLOSED OR BLOCKED, ALTERNATE PEDESTRIAN ACCESS SHALL BE PROVIDED USING TA-28 AND/OR TA-29 OF THE 2011 DELAWARE MANUAL ON UNIFORM TRAFFIC CONTROL DEVICES OR TO THE SATISFACTION OF THE ENGINEER. PEDESTRIAN DETOUR ROUTES OR ALTERNATE PEDESTRIAN FACILITIES SHALL CONSIST OF ADA COMPLIANT FACILITIES TO THE LEVEL OF WHICH EXISTS ON THE PEDESTRIAN ROUTE. THE COST FOR ANY PROVISIONS SHALL BE INCIDENTAL TO ITEM 801500 - MAINTENANCE OF TRAFFIC - ALL INCLUSIVE.

PEDESTRIAN MAINTENANCE OF TRAFFIC: THIS WORK SHALL CONSIST OF PROVIDING AND MAINTAINING AN ACCESSIBLE PEDESTRIAN ROUTE THROUGHOUT THE PROJECT'S LIMITS IN ACCORDANCE WITH THE AMERICANS WITH DISABILITIES ACT OF 1990 (ADA) TITLE II, PARAGRAPH 35.130.

THE CONTRACTOR SHALL BE REQUIRED TO REVIEW EACH CURB RAMP LOCATION AND SUBMIT THE APPROPRIATE MAINTENANCE OF TRAFFIC DETAIL AND DEVICES TO THE ENGINEER FOR EACH LOCATION AT LEAST 2-WEEKS BEFORE CONSTRUCTION FOR REVIEW, COMMENT, AND APPROVAL BY THE DISTRICT SAFETY OFFICER.

THE FOLLOWING CONSIDERATIONS SHALL BE TAKEN INTO ACCOUNT WHEN ADDRESSING ACCESSIBLE PEDESTRIAN MAINTENANCE OF TRAFFIC:

- ALL PEDESTRIANS, INCLUDING PERSONS WITH DISABILITIES, SHALL BE PROVIDED WITH A REASONABLY SAFE, CONVENIENT AND ACCESSIBLE PATH THAT REPLICATES AS MUCH AS PRACTICABLE THE EXISTING PEDESTRIAN FACILITIES.
- MAINTAIN ACCESS TO ALL BUSINESS AND RESIDENTS AT ALL TIMES.
- PROVIDE PEDESTRIAN ACCESS THRU OR AROUND THE WORK ZONE. IF A DETOUR IS CHOSEN THE CONTRACTOR MUST SUBMIT THE DETOUR ROUTE TO THE ENGINEER FOR REVIEW AND APPROVAL. THE DETOUR ROUTE MUST MEET OR EXCEED THE CURRENT CONDITIONS.
- WORK SHOULD BE PHASED SO THAT ALL AREAS OF AN INTERSECTION/SIDEWALK PATH ARE NOT UNDER CONSTRUCTION AT THE SAME TIME UNLESS A CLEAR PATH IS PROVIDED AND IDENTIFIED.
- TRAFFIC CONTROL DEVICES AND OTHER CONSTRUCTION MATERIALS AND FEATURES SHALL NOT INTRUDE INTO THE USABLE WIDTH OF THE SIDEWALK, TEMPORARY PATHWAY OR OTHER PEDESTRIAN FACILITY.
- SIGNS AND OTHER DEVICES MOUNTED LOWER THAN 7 FT ABOVE THE TEMPORARY

**GENERAL CONTRACT PLAN NOTES**

PEDESTRIAN PATHWAY SHALL NOT PROJECT MORE THAN 4 IN. INTO ACCESSIBLE PEDESTRIAN ROUTE.

- A SMOOTH, CONTINUOUS HARD SURFACE SHALL BE PROVIDED THROUGHOUT THE ENTIRE LENGTH AND WIDTH OF THE PEDESTRIAN ROUTE THROUGHOUT CONSTRUCTION. THERE SHALL BE NO CURBS OR VERTICAL ELEVATION CHANGES GREATER THAN ¼ IN. IN GRADE OR TERRAIN THAT COULD CAUSE TRIPPING OR BE A BARRIER TO WHEELCHAIR USE.

**SECTION 900**

51. EROSION CONTROL MULCH BLANKET SHALL BE USED IN ALL DISTURBED AREAS UNLESS DIRECTED OTHERWISE BY THE ENGINEER.

**ADDITIONAL PROJECT NOTES**

52. UNDERGROUND UTILITIES MAY BE PRESENT AT ALL LOCATIONS. THEREFORE, ALL STANDARD PRACTICES AND PROCEDURES REGARDING UTILITIES SHALL BE FOLLOWED. THE CONTRACTOR SHALL CONTACT MISS UTILITY OF DELAWARE PRIOR TO STARTING WORK. THE CONTRACTOR IS RESPONSIBLE FOR THE SUPPORT AND PROTECTION OF ALL UTILITIES WHEN EXCAVATING WHICH SHALL BE INCIDENTAL TO THE RESPECTIVE EXCAVATION ITEM(S). THE CONTRACTOR IS RESPONSIBLE FOR ENSURING PROPER CLEARANCES, INCLUDING SAFETY CLEARANCES, FROM OVERHEAD UTILITIES FOR CONSTRUCTION EQUIPMENT. THE CONTRACTOR IS ADVISED TO CHECK THE SITE FOR ACCESS PURPOSES FOR THEIR EQUIPMENT AND MAKE ARRANGEMENTS DIRECTLY WITH THE UTILITY COMPANIES FOR FIELD ADJUSTMENTS FOR ADEQUATE CLEARANCES, IF NECESSARY.

53. NO UTILITY RELOCATION INVOLVEMENT IS ANTICIPATED. SHOULD ANY CONFLICTS BE ENCOUNTERED DURING CONSTRUCTION REQUIRING ADJUSTMENT AND/OR RELOCATION OF THE AGENCIES' EXISTING FACILITIES, THE NECESSARY RELOCATION WORK SHALL BE ACCOMPLISHED BY THE RESPECTIVE AGENCIES' FORCES, AS DIRECTED BY THE DISTRICT ENGINEER. ANY ADJUSTMENTS AND/OR RELOCATIONS OF MUNICIPALLY OWNED FACILITIES SHALL BE DONE BY THE STATE'S CONTRACTOR IN ACCORDANCE WITH THE RESPECTIVE AGENCIES' STANDARD SPECIFICATIONS AS DIRECTED BY THE DISTRICT ENGINEER.

54. NO ENVIRONMENTAL PERMITS ARE REQUIRED FOR THIS WORK PROVIDED NO JURISDICTIONAL WETLANDS OR WATERS ARE IMPACTED. IF THERE IS ANY QUESTION AS TO WHETHER OR NOT A WATER OR WETLAND IS JURISDICTIONAL, CONTACT THE DEL DOT ENVIRONMENTAL SECTION AT 302-760-2264.

---

**DEPARTMENT OF TRANSPORTATION**

---

**CONTRACT NUMBER- T202504906 CANAL  
SUBDIVISION PAVING, NEW CASTLE COUNTY VI, 2025**

**(CAD) PAGE 29 OF 84**

---

**GENERAL CONTRACT PLAN NOTES**

55. IT IS ANTICIPATED THAT ALL WORK WILL OCCUR WITHIN DELDOT'S EXISTING RIGHT OF WAY OR EASEMENT AREAS. SHOULD THE NEED OCCUR TO TRESPASS ONTO PRIVATE PROPERTY; IT WILL BE THE RESPONSIBILITY OF THE PROJECT MANAGER TO SECURE SUCH TRESPASS NEEDS.

56. NO WORK NEAR OR WITHIN RAILROAD RIGHT-OF-WAY IS ANTICIPATED. IF ANY RAILROAD PROPERTY OR FACILITIES ARE NEAR OR WITHIN THE PROPOSED LIMITS OF WORK OR IF THE PROPOSED WORK ENCROACHES UPON THE RAILROAD'S RIGHT-OF-WAY, THE CONTRACTOR SHALL BE RESPONSIBLE FOR OBTAINING THE REQUIRED CLEARANCES AND INSURANCES FOR EACH INVOLVED RAILROAD IN ACCORDANCE WITH THE APPROPRIATE DELDOT MAINTENANCE OF RAILROAD TRAFFIC ITEM. DELDOT'S RAILROAD SECTION MANAGER MUST BE CONTACTED AT (302) 760-2183 TO COORDINATE THE EXECUTION OF THE APPROPRIATE AGREEMENTS AND AUTHORIZATIONS REQUIRED FROM ANY RAILROAD COMPANY INVOLVED, INCLUDING COORDINATION FOR RAILROAD FLAGGING, IF NECESSARY.

57. THE PROJECT MANAGER SHALL BE RESPONSIBLE FOR COORDINATING WITH THE TRAFFIC SECTION RELATING TO ANY IMPACTS TO TRAFFIC SECTION FACILITIES (INCLUDING BUT NOT LIMITED TO TRAFFIC LOOPS, JUNCTION WELLS ETC.) AT LEAST 4 WEEKS IN ADVANCE OF THE START OF THE ACTIVITY. PRIOR TO INITIATING ANY WORK ON THIS CONTRACT (OR SITES), THE PROJECT MANAGER SHALL BE RESPONSIBLE FOR PREPARING AND SUBMITTING FOR APPROVAL OF THE SAFETY SECTION, A MAINTENANCE OF TRAFFIC PLAN. SUFFICIENT TIME SHALL BE PROVIDED FOR THE REVIEW AND APPROVAL OF THE PLAN. THE MAINTENANCE OF TRAFFIC PLAN SHALL INCLUDE PROPOSED TIME RESTRICTIONS ON THE CLOSURE OF TRAVEL LANES SUBJECT TO THE APPROVAL OF THE SAFETY SECTION. TRAFFIC LOOPS MUST BE PUT BACK WITHIN 7 DAYS OF PAVING, FAILURE TO COMPLY WILL RESULT IN A SUSPENSION OF ALL OTHER CONTRACT WORK WITH TIME CHARGES CONTINUING TO BE ASSESSED.

58. THE DEPARTMENT RESERVES THE RIGHT TO REQUEST AN EXTENSION OF THIS CONTRACT, WITH THE AGREEMENT OF THE CONTRACTOR, AT THE CURRENT CONTRACT PRICES.

October 2024

DELAWARE DEPARTMENT OF TRANSPORTATION

CONTRACT NUMBER- T202504906

(CAD) PAGE 30 OF 84

CANAL

Contract is for various locations throughout New Castle County.

DETAILS SHEET

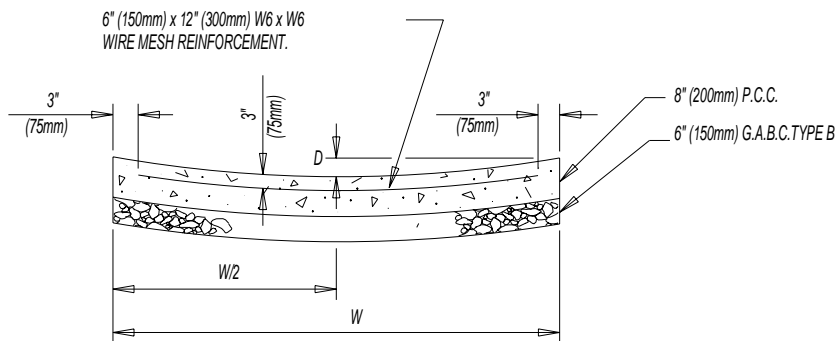
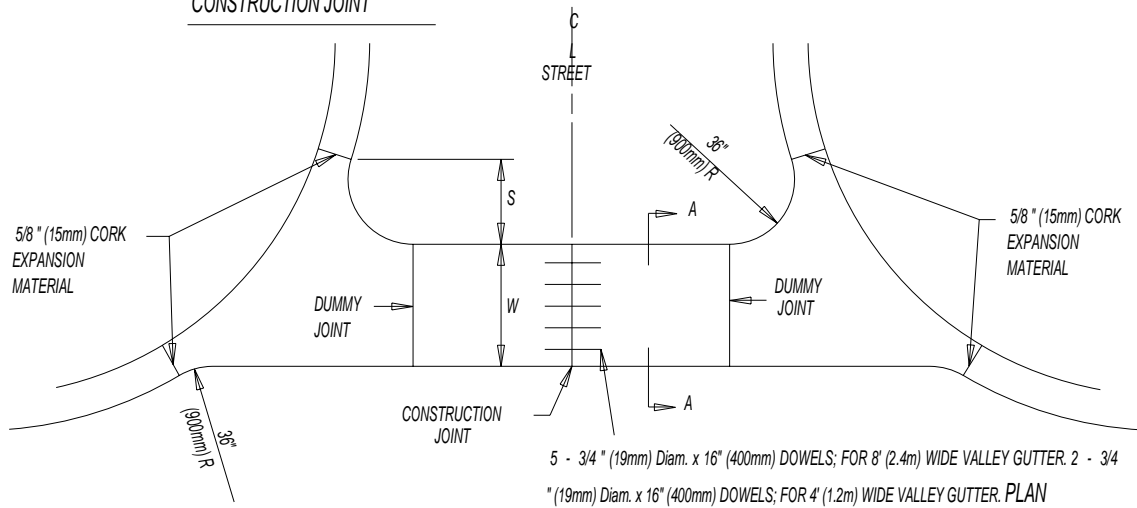
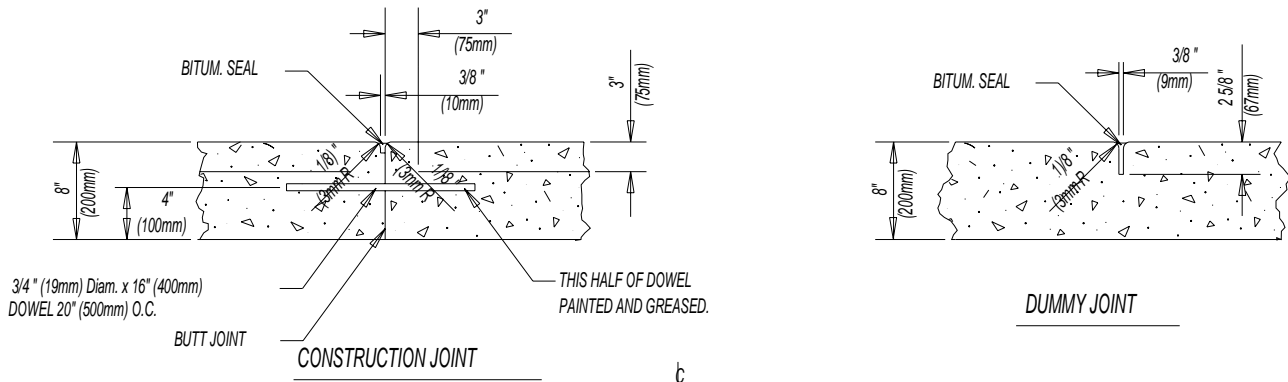

P.C.C. VALLEY GUTTER

WIDTH W	DEPTH D	OFFSET S
8' (2.4m)	3" (75mm)	16" (405mm)
4' (1.2m)	1 1/2" (38mm)	23 1/2" (585mm)

CANAL

Contract is for various locations throughout New Castle County.

DETAILS SHEET

REMOVE AND DISPOSE OF EXISTING FRAME AND COVER AS DIRECTED BY OWNER IF NOT UTILIZED IN THE ADJUSTMENT.  
PLACE NEW OR EXISTING FRAME AND COVER (AS REQUIRED) TO CORRECT ELEVATION, RECOLLAR AND PLACE BITUMINOUS CONCRETE PATCH. NEW FRAME AND COVER (IF REQUIRED) TO BE PROVIDED BY OWNER.

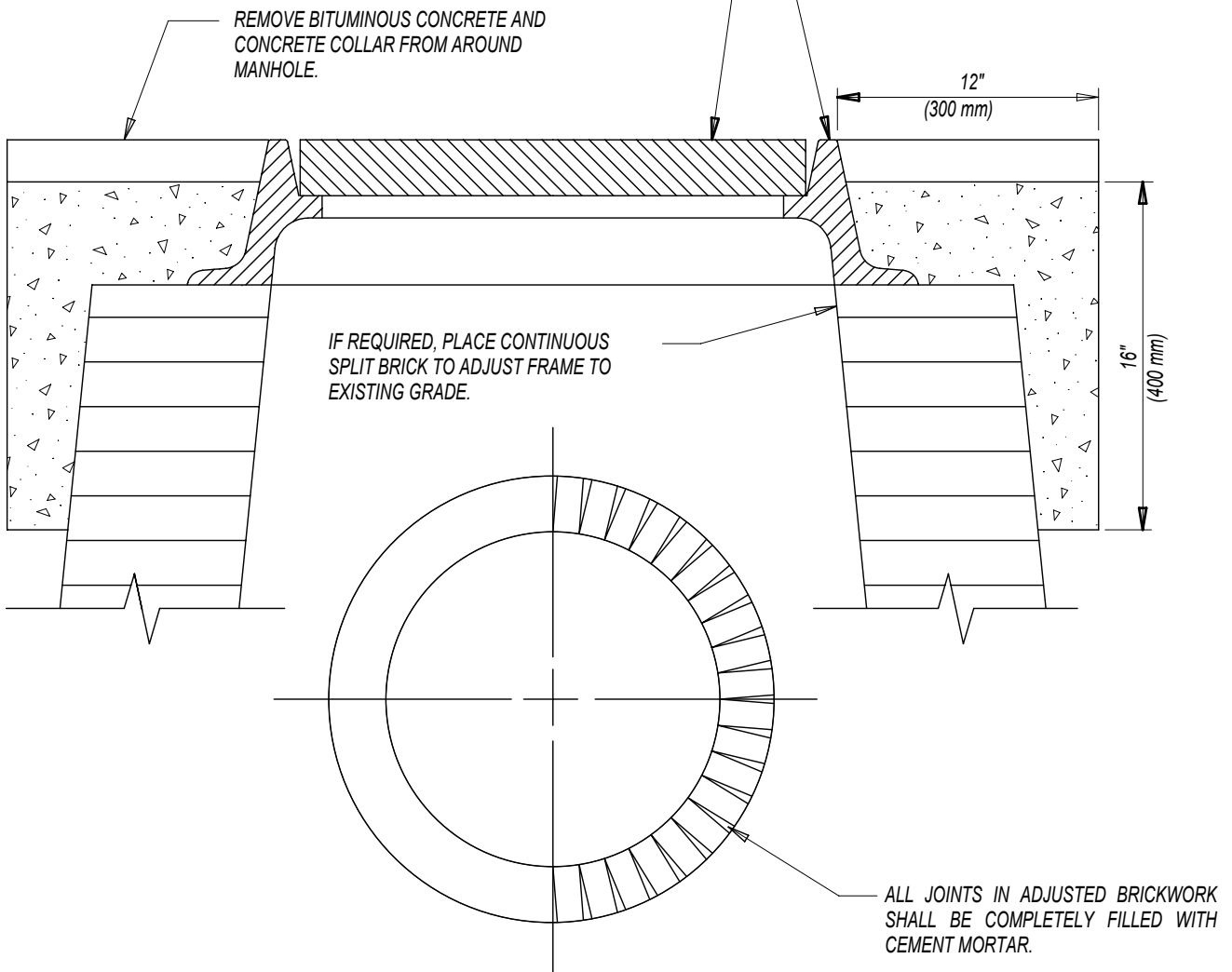

ADJUSTING AND REPAIRING MANHOLE

N.T.S.

NOTE: MANHOLES IN CONCRETE ROADWAYS SHALL BE SAWCUT FULL DEPTH TO THE SPECIFIED DIMENSION PRIOR TO ANY ADJUSTMENT BEING MADE. THE SAWCUTTING SHALL BE INCIDENTAL TO ITEM 602132.

**DELAWARE DEPARTMENT OF TRANSPORTATION**

**CONTRACT T202504906**

**(CAD) PAGE 32 OF 84**

**CANAL**

**SUBDIVISION PAVING, NEW CASTLE COUNTY VI, 2025**

**LOCATION 1 ACADEMY HILL - W.VIRGINIA COURT FROM OKLAHOMA STATE DRIVE TO  
END**

**LENGTH 60.9600 m 200.0000 L.F.**

**GENERAL IMPROVEMENTS**

**2" MILL AND OVERLAY (CURB WHERE NECESSARY)**

**COMMENTS:**

**MATERIAL ESTIMATE FOR LOCATION 1**

202000	EXCAVATION AND EMBANKMENT	15.00	C.Y.
211001	REMOVAL OF PORTLAND CEMENT CONCRETE PAVEMENT, CURB AND SIDEWALK	47.00	S.Y.
301001	GABC	3.00	C.Y.
301002	GABC, PATCHING	8.00	C.Y.
401005	SUPERPAVE TYPE C, PG 64-22 (CARBONATE STONE)	95.00	TON
401029	SUPERPAVE TYPE C, PG 64-22, PATCHING	27.00	TON
401030	SUPERPAVE TYPE B, PG 64-22, PATCHING	10.00	TON
404001	BITUMINOUS CRACK AND JOINT SEALING LESS THAN 3/4-INCH WIDE	66.00	L.F.
504001	CRACK AND JOINT SEALING LESS THAN 3/4 INCH WIDE	17.00	L.F.
602102	MANHOLE COVER(S)	1.00	EACH
602103	MANHOLE FRAME(S)	1.00	EACH
602131	ADJUSTING AND REPAIRING EXISTING DOUBLE DRAINAGE INLET	1.00	EACH
602132	ADJUSTING AND REPAIRING EXISTING MANHOLE	2.00	EACH
701019	I.PCC CURB AND GUTTER, TYPE 2	130.00	L.F.
705001	PCC SIDEWALK, 4"	52.00	S.F.
705002	PCC SIDEWALK, 6"	104.00	S.F.
710370	STEEL CASING PIPE, 4"	10.00	L.F.
760010	PAVEMENT MILLING, BITUMINOUS CONCRETE PAVEMENT	640.00	SY-IN
760011	PAVEMENT MILLING, BITUMINOUS CONCRETE PAVEMENT, TAPER CUT	430.00	SY-IN
762000	SAW CUTTING, BITUMINOUS CONCRETE	195.00	L.F.
762001	SAW CUTTING, CONCRETE, FULL DEPTH	20.00	L.F.
811001	FLAGGER, NEW CASTLE COUNTY	63.00	HOUR
811013	FLAGGER, NEW CASTLE COUNTY, OVERTIME	10.00	HOUR
905004	INLET SEDIMENT CONTROL, DRAINAGE INLET	2.00	EACH
908001	TOPSOIL	5.00	TON

DELAWARE DEPARTMENT OF TRANSPORTATION

CONTRACT T202504906

(CAD) PAGE 33 OF 84

CANAL

SUBDIVISION PAVING, NEW CASTLE COUNTY VI, 2025

---

LOCATION 1 ACADEMY HILL - W.VIRGINIA COURT FROM OKLAHOMA STATE DRIVE TO  
END

LENGTH 60.9600 m 200.0000 L.F.

**GENERAL IMPROVEMENTS**

2" MILL AND OVERLAY (CURB WHERE NECESSARY)

COMMENTS:

---

MATERIAL ESTIMATE FOR LOCATION 1

908016	PERMANENT GRASS SEEDING, SUBDIVISION	31.00	S.Y.
908020	EROSION CONTROL BLANKET MULCH	31.00	S.Y.

**DELAWARE DEPARTMENT OF TRANSPORTATION**

**CONTRACT T202504906**

**(CAD) PAGE 34 OF 84**

**CANAL**

SUBDIVISION PAVING, NEW CASTLE COUNTY VI, 2025

**LOCATION 2 BECKS LANDING - BRADLEY DRIVE FROM SALEM CHURCH ROAD TO END**

LENGTH 374.9040 m 1230.0000 L.F.

**GENERAL IMPROVEMENTS**

2" MILL AND OVERLAY(CURB WHERE NECESSARY)

**COMMENTS:**

**MATERIAL ESTIMATE FOR LOCATION 2**

201000	CLEARING AND GRUBBING	1.00	L.S.
202000	EXCAVATION AND EMBANKMENT	50.00	C.Y.
211001	REMOVAL OF PORTLAND CEMENT CONCRETE PAVEMENT, CURB AND SIDEWALK	309.00	S.Y.
301001	GABC	22.00	C.Y.
301002	GABC, PATCHING	52.00	C.Y.
401005	SUPERPAVE TYPE C, PG 64-22 (CARBONATE STONE)	460.00	TON
401029	SUPERPAVE TYPE C, PG 64-22, PATCHING	169.00	TON
401030	SUPERPAVE TYPE B, PG 64-22, PATCHING	75.00	TON
404001	BITUMINOUS CRACK AND JOINT SEALING LESS THAN 3/4-INCH WIDE	310.00	L.F.
602102	MANHOLE COVER(S)	1.00	EACH
602103	MANHOLE FRAME(S)	1.00	EACH
602130	ADJUSTING AND REPAIRING EXISTING DRAINAGE INLET	4.00	EACH
602132	ADJUSTING AND REPAIRING EXISTING MANHOLE	8.00	EACH
701018	I.PCC CURB AND GUTTER, TYPE 1-8	90.00	L.F.
701019	I.PCC CURB AND GUTTER, TYPE 2	750.00	L.F.
705001	PCC SIDEWALK, 4"	336.00	S.F.
705002	PCC SIDEWALK, 6"	672.00	S.F.
710002	ADJUST WATER VALVE BOXES	2.00	EACH
760010	PAVEMENT MILLING, BITUMINOUS CONCRETE PAVEMENT	7,340.00	SY-IN
762000	SAW CUTTING, BITUMINOUS CONCRETE	1,260.00	L.F.
762001	SAW CUTTING, CONCRETE, FULL DEPTH	124.00	L.F.
802003	ARROW PANELS TYPE C	6.00	EA-DY
808002	PROVIDE AND MAINTAIN TRUCK MOUNTED ATTENUATOR, TYPE II	7.00	EA-DY
811001	FLAGGER, NEW CASTLE COUNTY	367.00	HOUR
811013	FLAGGER, NEW CASTLE COUNTY, OVERTIME	39.00	HOUR
817002	PERMANENT PAVEMENT STRIPING, SYMBOL/LEGEND, ALKYD-THERMOPLASTIC	33.00	S.F.

DELAWARE DEPARTMENT OF TRANSPORTATION

CONTRACT T202504906

(CAD) PAGE 35 OF 84

CANAL

SUBDIVISION PAVING, NEW CASTLE COUNTY VI, 2025

---

LOCATION 2 BECKS LANDING - BRADLEY DRIVE FROM SALEM CHURCH ROAD TO END

LENGTH 374.9040 m 1230.0000 L.F.

GENERAL IMPROVEMENTS

2" MILL AND OVERLAY(CURB WHERE NECESSARY)

COMMENTS:

---

MATERIAL ESTIMATE FOR LOCATION 2

817004	TEMPORARY MARKINGS, PAINT, SYMBOL/LEGEND	33.00	S.F.
819018	INSTALLATION OR REMOVAL OF TRAFFIC SIGN(S) ON SINGLE SIGN POST	2.00	EACH
905004	INLET SEDIMENT CONTROL, DRAINAGE INLET	4.00	EACH
908001	TOPSOIL	34.00	TON
908016	PERMANENT GRASS SEEDING, SUBDIVISION	202.00	S.Y.
908020	EROSION CONTROL BLANKET MULCH	202.00	S.Y.

DELAWARE DEPARTMENT OF TRANSPORTATION

CONTRACT T202504906

(CAD) PAGE 36 OF 84

CANAL

SUBDIVISION PAVING, NEW CASTLE COUNTY VI, 2025

---

LOCATION 3 CARAVEL FARMS - CONGRESS DRIVE FROM CARAVEL DRIVE TO SAVANNAH DRIVE WEST

LENGTH 329.1840 m 1080.0000 L.F.

GENERAL IMPROVEMENTS  
2" MILL AND OVERLAY

COMMENTS:

---

MATERIAL ESTIMATE FOR LOCATION 3

202000	EXCAVATION AND EMBANKMENT	20.00	C.Y.
401005	SUPERPAVE TYPE C, PG 64-22 (CARBONATE STONE)	300.00	TON
401029	SUPERPAVE TYPE C, PG 64-22, PATCHING	9.00	TON
401030	SUPERPAVE TYPE B, PG 64-22, PATCHING	73.00	TON
404001	BITUMINOUS CRACK AND JOINT SEALING LESS THAN 3/4-INCH WIDE	200.00	L.F.
602102	MANHOLE COVER(S)	1.00	EACH
602103	MANHOLE FRAME(S)	1.00	EACH
602132	ADJUSTING AND REPAIRING EXISTING MANHOLE	4.00	EACH
760010	PAVEMENT MILLING, BITUMINOUS CONCRETE PAVEMENT	4,800.00	SY-IN
762000	SAW CUTTING, BITUMINOUS CONCRETE	158.00	L.F.
811001	FLAGGER, NEW CASTLE COUNTY	124.00	HOUR
811013	FLAGGER, NEW CASTLE COUNTY, OVERTIME	14.00	HOUR

DELAWARE DEPARTMENT OF TRANSPORTATION

CONTRACT T202504906

(CAD) PAGE 37 OF 84

CANAL

SUBDIVISION PAVING, NEW CASTLE COUNTY VI, 2025

---

**LOCATION 4** CARAVEL FARMS - PHOENIX DRIVE FROM SAVANNAH DRIVE WEST TO SAVANNAH DRIVE EAST

LENGTH 204.2160 m 670.0000 L.F.

**GENERAL IMPROVEMENTS**

2" MILL AND OVERLAY

COMMENTS:

---

MATERIAL ESTIMATE FOR LOCATION 4

202000	EXCAVATION AND EMBANKMENT	20.00	C.Y.
401005	SUPERPAVE TYPE C, PG 64-22 (CARBONATE STONE)	190.00	TON
401029	SUPERPAVE TYPE C, PG 64-22, PATCHING	1.00	TON
401030	SUPERPAVE TYPE B, PG 64-22, PATCHING	50.00	TON
404001	BITUMINOUS CRACK AND JOINT SEALING LESS THAN 3/4-INCH WIDE	64.00	L.F.
602132	ADJUSTING AND REPAIRING EXISTING MANHOLE	2.00	EACH
760010	PAVEMENT MILLING, BITUMINOUS CONCRETE PAVEMENT	3,000.00	SY-IN
762000	SAW CUTTING, BITUMINOUS CONCRETE	160.00	L.F.
811001	FLAGGER, NEW CASTLE COUNTY	77.00	HOUR
811013	FLAGGER, NEW CASTLE COUNTY, OVERTIME	9.00	HOUR

**DELAWARE DEPARTMENT OF TRANSPORTATION**

**CONTRACT T202504906**

**(CAD) PAGE 38 OF 84**

**CANAL**

**SUBDIVISION PAVING, NEW CASTLE COUNTY VI, 2025**

**LOCATION 5 CENTENNIAL VILLAGE - ROSS COURT FROM COLONIAL CIRCLE TO END**

**LENGTH 60.9600 m 200.0000 L.F.**

**GENERAL IMPROVEMENTS**

2" MILL AND OVERLAY(CURB WHERE NECESSARY)

**COMMENTS:**

**MATERIAL ESTIMATE FOR LOCATION 5**

202000	EXCAVATION AND EMBANKMENT	15.00	C.Y.
211001	REMOVAL OF PORTLAND CEMENT CONCRETE PAVEMENT, CURB AND SIDEWALK	144.00	S.Y.
301001	GABC	10.00	C.Y.
301002	GABC, PATCHING	24.00	C.Y.
401005	SUPERPAVE TYPE C, PG 64-22 (CARBONATE STONE)	80.00	TON
401029	SUPERPAVE TYPE C, PG 64-22, PATCHING	81.00	TON
401030	SUPERPAVE TYPE B, PG 64-22, PATCHING	10.00	TON
404001	BITUMINOUS CRACK AND JOINT SEALING LESS THAN 3/4-INCH WIDE	62.00	L.F.
602132	ADJUSTING AND REPAIRING EXISTING MANHOLE	1.00	EACH
701019	I.PCC CURB AND GUTTER, TYPE 2	400.00	L.F.
705001	PCC SIDEWALK, 4"	160.00	S.F.
705002	PCC SIDEWALK, 6"	320.00	S.F.
760010	PAVEMENT MILLING, BITUMINOUS CONCRETE PAVEMENT	1,280.00	SY-IN
762000	SAW CUTTING, BITUMINOUS CONCRETE	600.00	L.F.
762001	SAW CUTTING, CONCRETE, FULL DEPTH	60.00	L.F.
811001	FLAGGER, NEW CASTLE COUNTY	92.00	HOUR
811013	FLAGGER, NEW CASTLE COUNTY, OVERTIME	9.00	HOUR
908001	TOPSOIL	16.00	TON
908016	PERMANENT GRASS SEEDING, SUBDIVISION	96.00	S.Y.
908020	EROSION CONTROL BLANKET MULCH	96.00	S.Y.

DELAWARE DEPARTMENT OF TRANSPORTATION

CONTRACT T202504906

(CAD) PAGE 39 OF 84

CANAL

SUBDIVISION PAVING, NEW CASTLE COUNTY VI, 2025

---

LOCATION 6 CLEAR CREEK - DEARBORN LANE FROM CANONERO DRIVE TO  
DECIDEDLY LANE

LENGTH 426.7200 m 1400.0000 L.F.

GENERAL IMPROVEMENTS

2" MILL AND OVERLAY

COMMENTS:

---

MATERIAL ESTIMATE FOR LOCATION 6

202000	EXCAVATION AND EMBANKMENT	15.00	C.Y.
401005	SUPERPAVE TYPE C, PG 64-22 (CARBONATE STONE)	450.00	TON
401029	SUPERPAVE TYPE C, PG 64-22, PATCHING	1.00	TON
401030	SUPERPAVE TYPE B, PG 64-22, PATCHING	55.00	TON
404001	BITUMINOUS CRACK AND JOINT SEALING LESS THAN 3/4-INCH WIDE	200.00	L.F.
602132	ADJUSTING AND REPAIRING EXISTING MANHOLE	6.00	EACH
760010	PAVEMENT MILLING, BITUMINOUS CONCRETE PAVEMENT	7,140.00	SY-IN
762000	SAW CUTTING, BITUMINOUS CONCRETE	360.00	L.F.
811001	FLAGGER, NEW CASTLE COUNTY	173.00	HOUR
811013	FLAGGER, NEW CASTLE COUNTY, OVERTIME	17.00	HOUR

DELAWARE DEPARTMENT OF TRANSPORTATION

CONTRACT T202504906

(CAD) PAGE 40 OF 84

CANAL

SUBDIVISION PAVING, NEW CASTLE COUNTY VI, 2025

---

**LOCATION 7 CLEAR CREEK - RIVA RIDGE FROM CLEAR CREEK DRIVE TO END**

LENGTH 451.1040 m 1480.0000 L.F.

**GENERAL IMPROVEMENTS**

2" MILL AND OVERLAY

COMMENTS:

---

**MATERIAL ESTIMATE FOR LOCATION 7**

202000	EXCAVATION AND EMBANKMENT	18.00	C.Y.
401005	SUPERPAVE TYPE C, PG 64-22 (CARBONATE STONE)	510.00	TON
401029	SUPERPAVE TYPE C, PG 64-22, PATCHING	1.00	TON
401030	SUPERPAVE TYPE B, PG 64-22, PATCHING	60.00	TON
404001	BITUMINOUS CRACK AND JOINT SEALING LESS THAN 3/4-INCH WIDE	200.00	L.F.
602132	ADJUSTING AND REPAIRING EXISTING MANHOLE	7.00	EACH
760010	PAVEMENT MILLING, BITUMINOUS CONCRETE PAVEMENT	7,240.00	SY-IN
760011	PAVEMENT MILLING, BITUMINOUS CONCRETE PAVEMENT, TAPER CUT	430.00	SY-IN
762000	SAW CUTTING, BITUMINOUS CONCRETE	700.00	L.F.
811001	FLAGGER, NEW CASTLE COUNTY	195.00	HOUR
811013	FLAGGER, NEW CASTLE COUNTY, OVERTIME	20.00	HOUR

**DELAWARE DEPARTMENT OF TRANSPORTATION**

**CONTRACT T202504906**

**(CAD) PAGE 41 OF 84**

**CANAL**

**SUBDIVISION PAVING, NEW CASTLE COUNTY VI, 2025**

**LOCATION 8 COUNTRY CREEK - SPARROW COURT FROM CREEKSIDE DRIVE TO TURN-A-ROUND**

LENGTH 146.3040 m 480.0000 L.F.

**GENERAL IMPROVEMENTS**

2" MILL AND OVERLAY(CURB WHERE NECESSARY)

**COMMENTS:**

1 RAMP @ BARLEY

**MATERIAL ESTIMATE FOR LOCATION 8**

202000	EXCAVATION AND EMBANKMENT	20.00	C.Y.
211001	REMOVAL OF PORTLAND CEMENT CONCRETE PAVEMENT, CURB AND SIDEWALK	120.00	S.Y.
301001	GABC	9.00	C.Y.
301002	GABC, PATCHING	21.00	C.Y.
401005	SUPERPAVE TYPE C, PG 64-22 (CARBONATE STONE)	185.00	TON
401029	SUPERPAVE TYPE C, PG 64-22, PATCHING	68.00	TON
401030	SUPERPAVE TYPE B, PG 64-22, PATCHING	25.00	TON
404001	BITUMINOUS CRACK AND JOINT SEALING LESS THAN 3/4-INCH WIDE	103.00	L.F.
602130	ADJUSTING AND REPAIRING EXISTING DRAINAGE INLET	1.00	EACH
602131	ADJUSTING AND REPAIRING EXISTING DOUBLE DRAINAGE INLET	2.00	EACH
602132	ADJUSTING AND REPAIRING EXISTING MANHOLE	2.00	EACH
701013	PCC CURB, TYPE 1-8	2.00	L.F.
701019	I.PCC CURB AND GUTTER, TYPE 2	330.00	L.F.
705001	PCC SIDEWALK, 4"	132.00	S.F.
705002	PCC SIDEWALK, 6"	264.00	S.F.
705013	TRUNCATED DOME DETECTABLE WARNING SURFACE	10.00	S.F.
705008	PEDESTRIAN CONNECTION, TYPE 1	30.00	S.F.
705009	PEDESTRIAN CONNECTION, TYPE 2, 3, AND/OR 4	200.00	S.F.
710002	ADJUST WATER VALVE BOXES	4.00	EACH
760010	PAVEMENT MILLING, BITUMINOUS CONCRETE PAVEMENT	2,940.00	SY-IN
762000	SAW CUTTING, BITUMINOUS CONCRETE	495.00	L.F.
762001	SAW CUTTING, CONCRETE, FULL DEPTH	50.00	L.F.
811001	FLAGGER, NEW CASTLE COUNTY	164.00	HOUR
811013	FLAGGER, NEW CASTLE COUNTY, OVERTIME	18.00	HOUR
905004	INLET SEDIMENT CONTROL, DRAINAGE INLET	5.00	EACH

DELAWARE DEPARTMENT OF TRANSPORTATION

CONTRACT T202504906

(CAD) PAGE 42 OF 84

CANAL

SUBDIVISION PAVING, NEW CASTLE COUNTY VI, 2025

---

LOCATION 8 COUNTRY CREEK - SPARROW COURT FROM CREEKSIDE DRIVE TO TURN-A-ROUND

LENGTH 146.3040 m 480.0000 L.F.

**GENERAL IMPROVEMENTS**

2" MILL AND OVERLAY(CURB WHERE NECESSARY)

**COMMENTS:**

1 RAMP @ BARLEY

---

**MATERIAL ESTIMATE FOR LOCATION 8**

908001	TOPSOIL	17.00	TON
908016	PERMANENT GRASS SEEDING, SUBDIVISION	103.00	S.Y.
908020	EROSION CONTROL BLANKET MULCH	103.00	S.Y.

DELAWARE DEPARTMENT OF TRANSPORTATION

CONTRACT T202504906

(CAD) PAGE 43 OF 84

CANAL

SUBDIVISION PAVING, NEW CASTLE COUNTY VI, 2025

---

**LOCATION 9**                      **DRAWYERS CREEK - SEAN DRIVE FROM NANTUCKET DRIVE TO END**

LENGTH    249.9360 m                      820.0000 L.F.

**GENERAL IMPROVEMENTS**

2" MILL AND OVERLAY

COMMENTS:

---

**MATERIAL ESTIMATE FOR LOCATION 9**

202000	EXCAVATION AND EMBANKMENT	20.00	C.Y.
401005	SUPERPAVE TYPE C, PG 64-22 (CARBONATE STONE)	340.00	TON
401029	SUPERPAVE TYPE C, PG 64-22, PATCHING	1.00	TON
401030	SUPERPAVE TYPE B, PG 64-22, PATCHING	45.00	TON
404001	BITUMINOUS CRACK AND JOINT SEALING LESS THAN 3/4-INCH WIDE	22.00	L.F.
760010	PAVEMENT MILLING, BITUMINOUS CONCRETE PAVEMENT	4,280.00	SY-IN
760011	PAVEMENT MILLING, BITUMINOUS CONCRETE PAVEMENT, TAPER CUT	560.00	SY-IN
762000	SAW CUTTING, BITUMINOUS CONCRETE	40.00	L.F.
762001	SAW CUTTING, CONCRETE, FULL DEPTH	80.00	L.F.
811001	FLAGGER, NEW CASTLE COUNTY	116.00	HOUR
811013	FLAGGER, NEW CASTLE COUNTY, OVERTIME	13.00	HOUR

DELAWARE DEPARTMENT OF TRANSPORTATION

CONTRACT T202504906

(CAD) PAGE 44 OF 84

CANAL

SUBDIVISION PAVING, NEW CASTLE COUNTY VI, 2025

---

**LOCATION 10**                      **DRAWYERS CREEK - SLOOP LANE FROM NANTUCKET DRIVE TO END**

LENGTH      243.8400 m                                      800.0000 L.F.

**GENERAL IMPROVEMENTS**

2" MILL AND OVERLAY

COMMENTS:

---

**MATERIAL ESTIMATE FOR LOCATION 10**

202000	EXCAVATION AND EMBANKMENT	10.00	C.Y.
401005	SUPERPAVE TYPE C, PG 64-22 (CARBONATE STONE)	290.00	TON
401029	SUPERPAVE TYPE C, PG 64-22, PATCHING	1.00	TON
401030	SUPERPAVE TYPE B, PG 64-22, PATCHING	30.00	TON
404001	BITUMINOUS CRACK AND JOINT SEALING LESS THAN 3/4-INCH WIDE	44.00	L.F.
760010	PAVEMENT MILLING, BITUMINOUS CONCRETE PAVEMENT	3,560.00	SY-IN
760011	PAVEMENT MILLING, BITUMINOUS CONCRETE PAVEMENT, TAPER CUT	495.00	SY-IN
762000	SAW CUTTING, BITUMINOUS CONCRETE	160.00	L.F.
811001	FLAGGER, NEW CASTLE COUNTY	96.00	HOUR
811013	FLAGGER, NEW CASTLE COUNTY, OVERTIME	12.00	HOUR

**DELAWARE DEPARTMENT OF TRANSPORTATION**

**CONTRACT T202504906**

**(CAD) PAGE 45 OF 84**

**CANAL**

**SUBDIVISION PAVING, NEW CASTLE COUNTY VI, 2025**

**LOCATION 11 EAGLE TRACE - PAVIN COURT FROM NORMAN DRIVE @ CHANGE IN HOTMIX TO END**

LENGTH 143.2560 m 470.0000 L.F.

**GENERAL IMPROVEMENTS**

2" MILL AND OVERLAY(CURB WHERE NECESSARY)

**COMMENTS:**

2 RAMPS @ END (SKIP INTERSECTION W/ COUPLES - PAVED ON 20N3)

**MATERIAL ESTIMATE FOR LOCATION 11**

202000	EXCAVATION AND EMBANKMENT	15.00	C.Y.
211001	REMOVAL OF PORTLAND CEMENT CONCRETE PAVEMENT, CURB AND SIDEWALK	30.00	S.Y.
301001	GABC	3.00	C.Y.
301002	GABC, PATCHING	6.00	C.Y.
401005	SUPERPAVE TYPE C, PG 64-22 (CARBONATE STONE)	160.00	TON
401029	SUPERPAVE TYPE C, PG 64-22, PATCHING	18.00	TON
401030	SUPERPAVE TYPE B, PG 64-22, PATCHING	20.00	TON
404001	BITUMINOUS CRACK AND JOINT SEALING LESS THAN 3/4-INCH WIDE	122.00	L.F.
602130	ADJUSTING AND REPAIRING EXISTING DRAINAGE INLET	2.00	EACH
602131	ADJUSTING AND REPAIRING EXISTING DOUBLE DRAINAGE INLET	1.00	EACH
602132	ADJUSTING AND REPAIRING EXISTING MANHOLE	2.00	EACH
701013	PCC CURB, TYPE 1-8	4.00	L.F.
701019	I.PCC CURB AND GUTTER, TYPE 2	80.00	L.F.
705001	PCC SIDEWALK, 4"	32.00	S.F.
705002	PCC SIDEWALK, 6"	64.00	S.F.
705013	TRUNCATED DOME DETECTABLE WARNING SURFACE	20.00	S.F.
705008	PEDESTRIAN CONNECTION, TYPE 1	60.00	S.F.
705009	PEDESTRIAN CONNECTION, TYPE 2, 3, AND/OR 4	400.00	S.F.
760010	PAVEMENT MILLING, BITUMINOUS CONCRETE PAVEMENT	2,520.00	SY-IN
762000	SAW CUTTING, BITUMINOUS CONCRETE	120.00	L.F.
762001	SAW CUTTING, CONCRETE, FULL DEPTH	12.00	L.F.
811001	FLAGGER, NEW CASTLE COUNTY	115.00	HOURLY
811013	FLAGGER, NEW CASTLE COUNTY, OVERTIME	14.00	HOURLY
905004	INLET SEDIMENT CONTROL, DRAINAGE INLET	4.00	EACH
908001	TOPSOIL	11.00	TON

DELAWARE DEPARTMENT OF TRANSPORTATION

CONTRACT T202504906

(CAD) PAGE 46 OF 84

CANAL

SUBDIVISION PAVING, NEW CASTLE COUNTY VI, 2025

---

LOCATION 11 EAGLE TRACE - PAVIN COURT FROM NORMAN DRIVE @ CHANGE IN  
HOTMIX TO END

LENGTH 143.2560 m 470.0000 L.F.

**GENERAL IMPROVEMENTS**

2" MILL AND OVERLAY(CURB WHERE NECESSARY)

**COMMENTS:**

2 RAMPS @ END (SKIP INTERSECTION W/ COUPLES - PAVED ON 20N3)

---

**MATERIAL ESTIMATE FOR LOCATION 11**

908016	PERMANENT GRASS SEEDING, SUBDIVISION	67.00	S.Y.
908020	EROSION CONTROL BLANKET MULCH	67.00	S.Y.

DELAWARE DEPARTMENT OF TRANSPORTATION

CONTRACT T202504906

(CAD) PAGE 47 OF 84

CANAL

SUBDIVISION PAVING, NEW CASTLE COUNTY VI, 2025

---

LOCATION 12 FAIRWINDS - GREEN STREET FROM ROBIN DRIVE EAST TO END

LENGTH 188.9760 m 620.0000 L.F.

GENERAL IMPROVEMENTS

2" MILL AND OVERLAY

COMMENTS:

SEE MAP FOR LIMITS

---

MATERIAL ESTIMATE FOR LOCATION 12

202000	EXCAVATION AND EMBANKMENT	20.00	C.Y.
401005	SUPERPAVE TYPE C, PG 64-22 (CARBONATE STONE)	155.00	TON
401029	SUPERPAVE TYPE C, PG 64-22, PATCHING	1.00	TON
401030	SUPERPAVE TYPE B, PG 64-22, PATCHING	50.00	TON
404001	BITUMINOUS CRACK AND JOINT SEALING LESS THAN 3/4-INCH WIDE	40.00	L.F.
760010	PAVEMENT MILLING, BITUMINOUS CONCRETE PAVEMENT	2,480.00	SY-IN
762000	SAW CUTTING, BITUMINOUS CONCRETE	200.00	L.F.
811001	FLAGGER, NEW CASTLE COUNTY	64.00	HOUR
811013	FLAGGER, NEW CASTLE COUNTY, OVERTIME	6.00	HOUR

DELAWARE DEPARTMENT OF TRANSPORTATION

CONTRACT T202504906

(CAD) PAGE 48 OF 84

CANAL

SUBDIVISION PAVING, NEW CASTLE COUNTY VI, 2025

LOCATION 13 FOUR SEASONS - CLIPPER COURT FROM EDGEWATER WAY EAST TO SUMMER PARK CRESCENT

LENGTH 73.1520 m 240.0000 L.F.

GENERAL IMPROVEMENTS

2" MILL AND OVERLAY(CURB WHERE NECESSARY)

COMMENTS:

2 RAMPS @ EDGEWATER

MATERIAL ESTIMATE FOR LOCATION 13

202000	EXCAVATION AND EMBANKMENT	15.00	C.Y.
211001	REMOVAL OF PORTLAND CEMENT CONCRETE PAVEMENT, CURB AND SIDEWALK	102.00	S.Y.
301001	GABC	8.00	C.Y.
301002	GABC, PATCHING	18.00	C.Y.
401005	SUPERPAVE TYPE C, PG 64-22 (CARBONATE STONE)	75.00	TON
401029	SUPERPAVE TYPE C, PG 64-22, PATCHING	58.00	TON
401030	SUPERPAVE TYPE B, PG 64-22, PATCHING	10.00	TON
404001	BITUMINOUS CRACK AND JOINT SEALING LESS THAN 3/4-INCH WIDE	100.00	L.F.
602131	ADJUSTING AND REPAIRING EXISTING DOUBLE DRAINAGE INLET	2.00	EACH
602132	ADJUSTING AND REPAIRING EXISTING MANHOLE	1.00	EACH
701013	PCC CURB, TYPE 1-8	4.00	L.F.
701019	I.PCC CURB AND GUTTER, TYPE 2	280.00	L.F.
705001	PCC SIDEWALK, 4"	112.00	S.F.
705002	PCC SIDEWALK, 6"	224.00	S.F.
705013	TRUNCATED DOME DETECTABLE WARNING SURFACE	20.00	S.F.
705008	PEDESTRIAN CONNECTION, TYPE 1	60.00	S.F.
705009	PEDESTRIAN CONNECTION, TYPE 2, 3, AND/OR 4	400.00	S.F.
760010	PAVEMENT MILLING, BITUMINOUS CONCRETE PAVEMENT	1,180.00	SY-IN
762000	SAW CUTTING, BITUMINOUS CONCRETE	420.00	L.F.
762001	SAW CUTTING, CONCRETE, FULL DEPTH	42.00	L.F.
811001	FLAGGER, NEW CASTLE COUNTY	106.00	HOUR
811013	FLAGGER, NEW CASTLE COUNTY, OVERTIME	12.00	HOUR
905004	INLET SEDIMENT CONTROL, DRAINAGE INLET	4.00	EACH
908001	TOPSOIL	19.00	TON
908016	PERMANENT GRASS SEEDING, SUBDIVISION	115.00	S.Y.



**DELAWARE DEPARTMENT OF TRANSPORTATION**

**CONTRACT T202504906**

**(CAD) PAGE 50 OF 84**

**CANAL**

**SUBDIVISION PAVING, NEW CASTLE COUNTY VI, 2025**

**LOCATION 14                      FOUR SEASONS - LEAFY LANE FROM AUTUMN HORSESHOE @ CHANGE IN HOTMIX TO END**

LENGTH      126.4920 m                                      415.0000 L.F.

**GENERAL IMPROVEMENTS**

2" MILL AND OVERLAY(CURB WHERE NECESSARY)

**COMMENTS:**

**MATERIAL ESTIMATE FOR LOCATION 14**

202000	EXCAVATION AND EMBANKMENT	30.00	C.Y.
211001	REMOVAL OF PORTLAND CEMENT CONCRETE PAVEMENT, CURB AND SIDEWALK	166.00	S.Y.
301001	GABC	12.00	C.Y.
301002	GABC, PATCHING	28.00	C.Y.
401005	SUPERPAVE TYPE C, PG 64-22 (CARBONATE STONE)	130.00	TON
401029	SUPERPAVE TYPE C, PG 64-22, PATCHING	101.00	TON
401030	SUPERPAVE TYPE B, PG 64-22, PATCHING	38.00	TON
404001	BITUMINOUS CRACK AND JOINT SEALING LESS THAN 3/4-INCH WIDE	110.00	L.F.
602130	ADJUSTING AND REPAIRING EXISTING DRAINAGE INLET	2.00	EACH
602132	ADJUSTING AND REPAIRING EXISTING MANHOLE	1.00	EACH
701019	I.PCC CURB AND GUTTER, TYPE 2	460.00	L.F.
705001	PCC SIDEWALK, 4"	184.00	S.F.
705002	PCC SIDEWALK, 6"	368.00	S.F.
760010	PAVEMENT MILLING, BITUMINOUS CONCRETE PAVEMENT	2,040.00	SY-IN
762000	SAW CUTTING, BITUMINOUS CONCRETE	708.00	L.F.
762001	SAW CUTTING, CONCRETE, FULL DEPTH	69.00	L.F.
811001	FLAGGER, NEW CASTLE COUNTY	140.00	HOURL
811013	FLAGGER, NEW CASTLE COUNTY, OVERTIME	16.00	HOURL
905004	INLET SEDIMENT CONTROL, DRAINAGE INLET	2.00	EACH
908001	TOPSOIL	18.00	TON
908016	PERMANENT GRASS SEEDING, SUBDIVISION	110.00	S.Y.
908020	EROSION CONTROL BLANKET MULCH	110.00	S.Y.

**DELAWARE DEPARTMENT OF TRANSPORTATION**

**CONTRACT T202504906**

**(CAD) PAGE 51 OF 84**

**CANAL**

SUBDIVISION PAVING, NEW CASTLE COUNTY VI, 2025

**LOCATION 15 FRENCHTOWN WOODS - LILLE COURT FROM AVIGNON DRIVE TO CUL-DE-SAC**

LENGTH 147.8280 m 485.0000 L.F.

**GENERAL IMPROVEMENTS**

2" MILL AND OVERLAY (CURB WHERE NECESSARY)

**COMMENTS:**

4 RAMPS @ LYON; 2 RAMPS @ AVIGNON

**MATERIAL ESTIMATE FOR LOCATION 15**

202000	EXCAVATION AND EMBANKMENT	8.00	C.Y.
211001	REMOVAL OF PORTLAND CEMENT CONCRETE PAVEMENT, CURB AND SIDEWALK	15.00	S.Y.
301001	GABC	2.00	C.Y.
301002	GABC, PATCHING	3.00	C.Y.
401005	SUPERPAVE TYPE C, PG 64-22 (CARBONATE STONE)	195.00	TON
401029	SUPERPAVE TYPE C, PG 64-22, PATCHING	10.00	TON
401030	SUPERPAVE TYPE B, PG 64-22, PATCHING	25.00	TON
404001	BITUMINOUS CRACK AND JOINT SEALING LESS THAN 3/4-INCH WIDE	122.00	L.F.
602130	ADJUSTING AND REPAIRING EXISTING DRAINAGE INLET	1.00	EACH
602131	ADJUSTING AND REPAIRING EXISTING DOUBLE DRAINAGE INLET	3.00	EACH
602132	ADJUSTING AND REPAIRING EXISTING MANHOLE	4.00	EACH
701013	PCC CURB, TYPE 1-8	12.00	L.F.
701019	I.PCC CURB AND GUTTER, TYPE 2	40.00	L.F.
705001	PCC SIDEWALK, 4"	16.00	S.F.
705002	PCC SIDEWALK, 6"	32.00	S.F.
705013	TRUNCATED DOME DETECTABLE WARNING SURFACE	60.00	S.F.
705008	PEDESTRIAN CONNECTION, TYPE 1	180.00	S.F.
705009	PEDESTRIAN CONNECTION, TYPE 2, 3, AND/OR 4	1,200.00	S.F.
760010	PAVEMENT MILLING, BITUMINOUS CONCRETE PAVEMENT	2,180.00	SY-IN
760011	PAVEMENT MILLING, BITUMINOUS CONCRETE PAVEMENT, TAPER CUT	430.00	SY-IN
762000	SAW CUTTING, BITUMINOUS CONCRETE	60.00	L.F.
762001	SAW CUTTING, CONCRETE, FULL DEPTH	6.00	L.F.
811001	FLAGGER, NEW CASTLE COUNTY	162.00	HOUR
811013	FLAGGER, NEW CASTLE COUNTY, OVERTIME	18.00	HOUR
905004	INLET SEDIMENT CONTROL, DRAINAGE INLET	10.00	EACH

DELAWARE DEPARTMENT OF TRANSPORTATION

CONTRACT T202504906

(CAD) PAGE 52 OF 84

CANAL

SUBDIVISION PAVING, NEW CASTLE COUNTY VI, 2025

---

LOCATION 15 FRENCHTOWN WOODS - LILLE COURT FROM AVIGNON DRIVE TO CUL-DE-SAC

LENGTH 147.8280 m 485.0000 L.F.

**GENERAL IMPROVEMENTS**

2" MILL AND OVERLAY (CURB WHERE NECESSARY)

**COMMENTS:**

4 RAMPS @ LYON; 2 RAMPS @ AVIGNON

---

**MATERIAL ESTIMATE FOR LOCATION 15**

908001	TOPSOIL	26.00	TON
908016	PERMANENT GRASS SEEDING, SUBDIVISION	154.00	S.Y.
908020	EROSION CONTROL BLANKET MULCH	154.00	S.Y.

DELAWARE DEPARTMENT OF TRANSPORTATION

CONTRACT T202504906

(CAD) PAGE 53 OF 84

CANAL

SUBDIVISION PAVING, NEW CASTLE COUNTY VI, 2025

---

**LOCATION 16**                      **GAM S CREST - GINA DRIVE FROM MAIN STREET TO NOEL ROAD**

LENGTH      228.6000 m                      750.0000 L.F.

**GENERAL IMPROVEMENTS**

2" MILL AND OVERLAY(CURB WHERE NECESSARY)

**COMMENTS:**

2 RAMPS @ MAIN

---

**MATERIAL ESTIMATE FOR LOCATION 16**

202000	EXCAVATION AND EMBANKMENT	15.00	C.Y.
211001	REMOVAL OF PORTLAND CEMENT CONCRETE PAVEMENT, CURB AND SIDEWALK	1.00	S.Y.
301001	GABC	1.00	C.Y.
301002	GABC, PATCHING	1.00	C.Y.
401005	SUPERPAVE TYPE C, PG 64-22 (CARBONATE STONE)	190.00	TON
401029	SUPERPAVE TYPE C, PG 64-22, PATCHING	2.00	TON
401030	SUPERPAVE TYPE B, PG 64-22, PATCHING	25.00	TON
404001	BITUMINOUS CRACK AND JOINT SEALING LESS THAN 3/4-INCH WIDE	80.00	L.F.
701013	PCC CURB, TYPE 1-8	4.00	L.F.
705013	TRUNCATED DOME DETECTABLE WARNING SURFACE	20.00	S.F.
705008	PEDESTRIAN CONNECTION, TYPE 1	60.00	S.F.
705009	PEDESTRIAN CONNECTION, TYPE 2, 3, AND/OR 4	400.00	S.F.
760010	PAVEMENT MILLING, BITUMINOUS CONCRETE PAVEMENT	3,000.00	SY-IN
762000	SAW CUTTING, BITUMINOUS CONCRETE	120.00	L.F.
811001	FLAGGER, NEW CASTLE COUNTY	83.00	HOUR
811013	FLAGGER, NEW CASTLE COUNTY, OVERTIME	10.00	HOUR
908001	TOPSOIL	8.00	TON
908016	PERMANENT GRASS SEEDING, SUBDIVISION	48.00	S.Y.
908020	EROSION CONTROL BLANKET MULCH	48.00	S.Y.

**DELAWARE DEPARTMENT OF TRANSPORTATION**

**CONTRACT T202504906**

**(CAD) PAGE 54 OF 84**

**CANAL**

**SUBDIVISION PAVING, NEW CASTLE COUNTY VI, 2025**

**LOCATION 17 GARWOOD - GLORIA COURT FROM GARWOOD DRIVE TO END**

**LENGTH 73.1520 m 240.0000 L.F.**

**GENERAL IMPROVEMENTS**

2" MILL AND OVERLAY(CURB WHERE NECESSARY)

**COMMENTS:**

**MATERIAL ESTIMATE FOR LOCATION 17**

202000	EXCAVATION AND EMBANKMENT	15.00	C.Y.
211001	REMOVAL OF PORTLAND CEMENT CONCRETE PAVEMENT, CURB AND SIDEWALK	108.00	S.Y.
301001	GABC	8.00	C.Y.
301002	GABC, PATCHING	18.00	C.Y.
401005	SUPERPAVE TYPE C, PG 64-22 (CARBONATE STONE)	145.00	TON
401029	SUPERPAVE TYPE C, PG 64-22, PATCHING	61.00	TON
401030	SUPERPAVE TYPE B, PG 64-22, PATCHING	10.00	TON
404001	BITUMINOUS CRACK AND JOINT SEALING LESS THAN 3/4-INCH WIDE	52.00	L.F.
602100	DRAINAGE INLET GRATE(S)	2.00	EACH
602101	DRAINAGE INLET FRAME(S)	1.00	EACH
602130	ADJUSTING AND REPAIRING EXISTING DRAINAGE INLET	2.00	EACH
701019	I.PCC CURB AND GUTTER, TYPE 2	300.00	L.F.
705001	PCC SIDEWALK, 4"	120.00	S.F.
705002	PCC SIDEWALK, 6"	240.00	S.F.
760010	PAVEMENT MILLING, BITUMINOUS CONCRETE PAVEMENT	1,160.00	SY-IN
762000	SAW CUTTING, BITUMINOUS CONCRETE	450.00	L.F.
762001	SAW CUTTING, CONCRETE, FULL DEPTH	45.00	L.F.
811001	FLAGGER, NEW CASTLE COUNTY	102.00	HOUR
811013	FLAGGER, NEW CASTLE COUNTY, OVERTIME	12.00	HOUR
905004	INLET SEDIMENT CONTROL, DRAINAGE INLET	2.00	EACH
908001	TOPSOIL	12.00	TON
908016	PERMANENT GRASS SEEDING, SUBDIVISION	72.00	S.Y.
908020	EROSION CONTROL BLANKET MULCH	72.00	S.Y.

**DELAWARE DEPARTMENT OF TRANSPORTATION**

**CONTRACT T202504906**

**(CAD) PAGE 55 OF 84**

**CANAL**

**SUBDIVISION PAVING, NEW CASTLE COUNTY VI, 2025**

**LOCATION 18 GLASGOW PINES - THAYER COURT FROM THORNHILL DRIVE TO END**

**LENGTH 117.9576 m 387.0000 L.F.**

**GENERAL IMPROVEMENTS**

2" MILL AND OVERLAY(CURB WHERE NECESSARY)

**COMMENTS:**

**MATERIAL ESTIMATE FOR LOCATION 18**

202000	EXCAVATION AND EMBANKMENT	13.00	C.Y.
211001	REMOVAL OF PORTLAND CEMENT CONCRETE PAVEMENT, CURB AND SIDEWALK	126.00	S.Y.
301001	GABC	9.00	C.Y.
301002	GABC, PATCHING	21.00	C.Y.
401005	SUPERPAVE TYPE C, PG 64-22 (CARBONATE STONE)	180.00	TON
401029	SUPERPAVE TYPE C, PG 64-22, PATCHING	71.00	TON
401030	SUPERPAVE TYPE B, PG 64-22, PATCHING	15.00	TON
404001	BITUMINOUS CRACK AND JOINT SEALING LESS THAN 3/4-INCH WIDE	81.00	L.F.
602132	ADJUSTING AND REPAIRING EXISTING MANHOLE	1.00	EACH
701019	I.PCC CURB AND GUTTER, TYPE 2	350.00	L.F.
705001	PCC SIDEWALK, 4"	140.00	S.F.
705002	PCC SIDEWALK, 6"	280.00	S.F.
710002	ADJUST WATER VALVE BOXES	5.00	EACH
760010	PAVEMENT MILLING, BITUMINOUS CONCRETE PAVEMENT	1,920.00	SY-IN
760011	PAVEMENT MILLING, BITUMINOUS CONCRETE PAVEMENT, TAPER CUT	560.00	SY-IN
762000	SAW CUTTING, BITUMINOUS CONCRETE	525.00	L.F.
762001	SAW CUTTING, CONCRETE, FULL DEPTH	53.00	L.F.
811001	FLAGGER, NEW CASTLE COUNTY	127.00	HOUR
811013	FLAGGER, NEW CASTLE COUNTY, OVERTIME	15.00	HOUR
905004	INLET SEDIMENT CONTROL, DRAINAGE INLET	3.00	EACH
908001	TOPSOIL	14.00	TON
908016	PERMANENT GRASS SEEDING, SUBDIVISION	84.00	S.Y.
908020	EROSION CONTROL BLANKET MULCH	84.00	S.Y.

**DELAWARE DEPARTMENT OF TRANSPORTATION**

**CONTRACT T202504906**

**(CAD) PAGE 56 OF 84**

**CANAL**

**SUBDIVISION PAVING, NEW CASTLE COUNTY VI, 2025**

**LOCATION 19 HEATHER WOODS - EVERGREEN DRIVE FROM CUL-DE-SAC TO CUL-DE-SAC...ENDS.**

LENGTH 320.0400 m 1050.0000 L.F.

**GENERAL IMPROVEMENTS**

2" MILL AND OVERLAY(CURB WHERE NECESSARY)

**COMMENTS:**

INCLUDES PONDEROSA STUB - 2 RAMPS @ HEATHER; 2 RAMPS @ PONDEROSA

**MATERIAL ESTIMATE FOR LOCATION 19**

202000	EXCAVATION AND EMBANKMENT	30.00	C.Y.
211001	REMOVAL OF PORTLAND CEMENT CONCRETE PAVEMENT, CURB AND SIDEWALK	192.00	S.Y.
301001	GABC	14.00	C.Y.
301002	GABC, PATCHING	33.00	C.Y.
401005	SUPERPAVE TYPE C, PG 64-22 (CARBONATE STONE)	460.00	TON
401029	SUPERPAVE TYPE C, PG 64-22, PATCHING	108.00	TON
401030	SUPERPAVE TYPE B, PG 64-22, PATCHING	50.00	TON
404001	BITUMINOUS CRACK AND JOINT SEALING LESS THAN 3/4-INCH WIDE	265.00	L.F.
602130	ADJUSTING AND REPAIRING EXISTING DRAINAGE INLET	2.00	EACH
602131	ADJUSTING AND REPAIRING EXISTING DOUBLE DRAINAGE INLET	1.00	EACH
602132	ADJUSTING AND REPAIRING EXISTING MANHOLE	7.00	EACH
701013	PCC CURB, TYPE 1-8	8.00	L.F.
701019	I.PCC CURB AND GUTTER, TYPE 2	530.00	L.F.
705001	PCC SIDEWALK, 4"	212.00	S.F.
705002	PCC SIDEWALK, 6"	424.00	S.F.
705013	TRUNCATED DOME DETECTABLE WARNING SURFACE	40.00	S.F.
705008	PEDESTRIAN CONNECTION, TYPE 1	120.00	S.F.
705009	PEDESTRIAN CONNECTION, TYPE 2, 3, AND/OR 4	800.00	S.F.
760010	PAVEMENT MILLING, BITUMINOUS CONCRETE PAVEMENT	5,240.00	SY-IN
760011	PAVEMENT MILLING, BITUMINOUS CONCRETE PAVEMENT, TAPER CUT	990.00	SY-IN
762000	SAW CUTTING, BITUMINOUS CONCRETE	795.00	L.F.
762001	SAW CUTTING, CONCRETE, FULL DEPTH	80.00	L.F.
811001	FLAGGER, NEW CASTLE COUNTY	311.00	HOURLY
811013	FLAGGER, NEW CASTLE COUNTY, OVERTIME	30.00	HOURLY
905004	INLET SEDIMENT CONTROL, DRAINAGE INLET	4.00	EACH

DELAWARE DEPARTMENT OF TRANSPORTATION

CONTRACT T202504906

(CAD) PAGE 57 OF 84

CANAL

SUBDIVISION PAVING, NEW CASTLE COUNTY VI, 2025

---

LOCATION 19 HEATHER WOODS - EVERGREEN DRIVE FROM CUL-DE-SAC TO CUL-DE-SAC...ENDS.

LENGTH 320.0400 m 1050.0000 L.F.

**GENERAL IMPROVEMENTS**

2" MILL AND OVERLAY(CURB WHERE NECESSARY)

**COMMENTS:**

INCLUDES PONDEROSA STUB - 2 RAMPS @ HEATHER; 2 RAMPS @ PONDEROSA

---

**MATERIAL ESTIMATE FOR LOCATION 19**

908001	TOPSOIL	37.00	TON
908016	PERMANENT GRASS SEEDING, SUBDIVISION	223.00	S.Y.
908020	EROSION CONTROL BLANKET MULCH	223.00	S.Y.

**DELAWARE DEPARTMENT OF TRANSPORTATION**

**CONTRACT T202504906**

**(CAD) PAGE 58 OF 84**

**CANAL**

**SUBDIVISION PAVING, NEW CASTLE COUNTY VI, 2025**

**LOCATION 20 HEATHER WOODS - YEW ROAD FROM HEATHER ROAD TO HEATHER ROAD**

**LENGTH 207.2640 m 680.0000 L.F.**

**GENERAL IMPROVEMENTS**

2" MILL AND OVERLAY(CURB WHERE NECESSARY)

**COMMENTS:**

2 RAMPS @ HEATHER; 2 RAMPS @ CEDAR; 2 RAMPS @ HEATHER

**MATERIAL ESTIMATE FOR LOCATION 20**

202000	EXCAVATION AND EMBANKMENT	30.00	C.Y.
211001	REMOVAL OF PORTLAND CEMENT CONCRETE PAVEMENT, CURB AND SIDEWALK	195.00	S.Y.
301001	GABC	15.00	C.Y.
301002	GABC, PATCHING	33.00	C.Y.
401005	SUPERPAVE TYPE C, PG 64-22 (CARBONATE STONE)	230.00	TON
401029	SUPERPAVE TYPE C, PG 64-22, PATCHING	110.00	TON
401030	SUPERPAVE TYPE B, PG 64-22, PATCHING	30.00	TON
404001	BITUMINOUS CRACK AND JOINT SEALING LESS THAN 3/4-INCH WIDE	192.00	L.F.
602130	ADJUSTING AND REPAIRING EXISTING DRAINAGE INLET	2.00	EACH
602131	ADJUSTING AND REPAIRING EXISTING DOUBLE DRAINAGE INLET	1.00	EACH
602132	ADJUSTING AND REPAIRING EXISTING MANHOLE	3.00	EACH
701013	PCC CURB, TYPE 1-8	12.00	L.F.
701019	I.PCC CURB AND GUTTER, TYPE 2	540.00	L.F.
705001	PCC SIDEWALK, 4"	216.00	S.F.
705002	PCC SIDEWALK, 6"	432.00	S.F.
705013	TRUNCATED DOME DETECTABLE WARNING SURFACE	60.00	S.F.
705008	PEDESTRIAN CONNECTION, TYPE 1	180.00	S.F.
705009	PEDESTRIAN CONNECTION, TYPE 2, 3, AND/OR 4	1,200.00	S.F.
710370	STEEL CASING PIPE, 4"	10.00	L.F.
760010	PAVEMENT MILLING, BITUMINOUS CONCRETE PAVEMENT	3,470.00	SY-IN
762000	SAW CUTTING, BITUMINOUS CONCRETE	810.00	L.F.
762001	SAW CUTTING, CONCRETE, FULL DEPTH	81.00	L.F.
811001	FLAGGER, NEW CASTLE COUNTY	248.00	HOUR
811013	FLAGGER, NEW CASTLE COUNTY, OVERTIME	27.00	HOUR
905004	INLET SEDIMENT CONTROL, DRAINAGE INLET	4.00	EACH
908001	TOPSOIL	46.00	TON

DELAWARE DEPARTMENT OF TRANSPORTATION

CONTRACT T202504906

(CAD) PAGE 59 OF 84

CANAL

SUBDIVISION PAVING, NEW CASTLE COUNTY VI, 2025

---

**LOCATION 20** HEATHER WOODS - YEW ROAD FROM HEATHER ROAD TO HEATHER ROAD

LENGTH 207.2640 m 680.0000 L.F.

**GENERAL IMPROVEMENTS**

2" MILL AND OVERLAY(CURB WHERE NECESSARY)

**COMMENTS:**

2 RAMPS @ HEATHER; 2 RAMPS @ CEDAR; 2 RAMPS @ HEATHER

---

**MATERIAL ESTIMATE FOR LOCATION 20**

908016	PERMANENT GRASS SEEDING, SUBDIVISION	274.00	S.Y.
908020	EROSION CONTROL BLANKET MULCH	274.00	S.Y.



DELAWARE DEPARTMENT OF TRANSPORTATION

CONTRACT T202504906

(CAD) PAGE 61 OF 84

CANAL

SUBDIVISION PAVING, NEW CASTLE COUNTY VI, 2025

---

**LOCATION 22 OAKWOOD - MAGNUM DRIVE FROM WEST MOYER DRIVE TO EAST MOYER DRIVE**

LENGTH 168.2496 m 552.0000 L.F.

**GENERAL IMPROVEMENTS**

2" MILL AND OVERLAY(CURB WHERE NECESSARY)

**COMMENTS:**

---

**MATERIAL ESTIMATE FOR LOCATION 22**

202000	EXCAVATION AND EMBANKMENT	25.00	C.Y.
211001	REMOVAL OF PORTLAND CEMENT CONCRETE PAVEMENT, CURB AND SIDEWALK	169.00	S.Y.
301001	GABC	12.00	C.Y.
301002	GABC, PATCHING	28.00	C.Y.
401005	SUPERPAVE TYPE C, PG 64-22 (CARBONATE STONE)	200.00	TON
401029	SUPERPAVE TYPE C, PG 64-22, PATCHING	95.00	TON
401030	SUPERPAVE TYPE B, PG 64-22, PATCHING	25.00	TON
404001	BITUMINOUS CRACK AND JOINT SEALING LESS THAN 3/4-INCH WIDE	170.00	L.F.
602131	ADJUSTING AND REPAIRING EXISTING DOUBLE DRAINAGE INLET	2.00	EACH
602132	ADJUSTING AND REPAIRING EXISTING MANHOLE	3.00	EACH
701019	I.PCC CURB AND GUTTER, TYPE 2	470.00	L.F.
705001	PCC SIDEWALK, 4"	188.00	S.F.
705002	PCC SIDEWALK, 6"	376.00	S.F.
760010	PAVEMENT MILLING, BITUMINOUS CONCRETE PAVEMENT	3,140.00	SY-IN
762000	SAW CUTTING, BITUMINOUS CONCRETE	705.00	L.F.
762001	SAW CUTTING, CONCRETE, FULL DEPTH	71.00	L.F.
811001	FLAGGER, NEW CASTLE COUNTY	170.00	HOURLY
811013	FLAGGER, NEW CASTLE COUNTY, OVERTIME	18.00	HOURLY
905004	INLET SEDIMENT CONTROL, DRAINAGE INLET	4.00	EACH
908001	TOPSOIL	19.00	TON
908016	PERMANENT GRASS SEEDING, SUBDIVISION	113.00	S.Y.
908020	EROSION CONTROL BLANKET MULCH	113.00	S.Y.

**DELAWARE DEPARTMENT OF TRANSPORTATION**

**CONTRACT T202504906**

**(CAD) PAGE 62 OF 84**

**CANAL**

**SUBDIVISION PAVING, NEW CASTLE COUNTY VI, 2025**

**LOCATION 23 PORTER SQUARE - DEROSE COURT FROM WORTHY DOWN AVENUE TO END**

LENGTH 167.6400 m 550.0000 L.F.

**GENERAL IMPROVEMENTS**

2" MILL AND OVERLAY(CURB WHERE NECESSARY)

**COMMENTS:**

ESTIMATE INCLUDES INTERSECTION W/ WORTHY DOWN - 2 RAMPS @ WORTHY DOWN; 2 RAMPS NEAR HOUSE #315 DEROSE

**MATERIAL ESTIMATE FOR LOCATION 23**

202000	EXCAVATION AND EMBANKMENT	25.00	C.Y.
211001	REMOVAL OF PORTLAND CEMENT CONCRETE PAVEMENT, CURB AND SIDEWALK	145.00	S.Y.
301001	GABC	11.00	C.Y.
301002	GABC, PATCHING	25.00	C.Y.
401005	SUPERPAVE TYPE C, PG 64-22 (CARBONATE STONE)	235.00	TON
401029	SUPERPAVE TYPE C, PG 64-22, PATCHING	82.00	TON
401030	SUPERPAVE TYPE B, PG 64-22, PATCHING	20.00	TON
404001	BITUMINOUS CRACK AND JOINT SEALING LESS THAN 3/4-INCH WIDE	160.00	L.F.
602131	ADJUSTING AND REPAIRING EXISTING DOUBLE DRAINAGE INLET	1.00	EACH
602132	ADJUSTING AND REPAIRING EXISTING MANHOLE	4.00	EACH
701013	PCC CURB, TYPE 1-8	8.00	L.F.
701019	I.PCC CURB AND GUTTER, TYPE 2	400.00	L.F.
705001	PCC SIDEWALK, 4"	160.00	S.F.
705002	PCC SIDEWALK, 6"	320.00	S.F.
705013	TRUNCATED DOME DETECTABLE WARNING SURFACE	40.00	S.F.
705008	PEDESTRIAN CONNECTION, TYPE 1	120.00	S.F.
705009	PEDESTRIAN CONNECTION, TYPE 2, 3, AND/OR 4	800.00	S.F.
760010	PAVEMENT MILLING, BITUMINOUS CONCRETE PAVEMENT	2,360.00	SY-IN
760011	PAVEMENT MILLING, BITUMINOUS CONCRETE PAVEMENT, TAPER CUT	645.00	SY-IN
762000	SAW CUTTING, BITUMINOUS CONCRETE	600.00	L.F.
762001	SAW CUTTING, CONCRETE, FULL DEPTH	60.00	L.F.
811001	FLAGGER, NEW CASTLE COUNTY	190.00	HOUR
811013	FLAGGER, NEW CASTLE COUNTY, OVERTIME	19.00	HOUR
905004	INLET SEDIMENT CONTROL, DRAINAGE INLET	2.00	EACH
908001	TOPSOIL	32.00	TON

DELAWARE DEPARTMENT OF TRANSPORTATION

CONTRACT T202504906

(CAD) PAGE 63 OF 84

CANAL

SUBDIVISION PAVING, NEW CASTLE COUNTY VI, 2025

---

LOCATION 23 PORTER SQUARE - DEROSE COURT FROM WORTHY DOWN AVENUE TO  
END

LENGTH 167.6400 m 550.0000 L.F.

**GENERAL IMPROVEMENTS**

2" MILL AND OVERLAY(CURB WHERE NECESSARY)

**COMMENTS:**

ESTIMATE INCLUDES INTERSECTION W/ WORTHY DOWN - 2 RAMPS @ WORTHY DOWN; 2  
RAMPS NEAR HOUSE #315 DEROSE

---

**MATERIAL ESTIMATE FOR LOCATION 23**

908016	PERMANENT GRASS SEEDING, SUBDIVISION	192.00	S.Y.
908020	EROSION CONTROL BLANKET MULCH	192.00	S.Y.

**DELAWARE DEPARTMENT OF TRANSPORTATION**

**CONTRACT T202504906**

**(CAD) PAGE 64 OF 84**

**CANAL**

SUBDIVISION PAVING, NEW CASTLE COUNTY VI, 2025

**LOCATION 24 PORTER SQUARE - DOVER COURT FROM CUL-DE-SAC TO CUL-DE-SAC**

LENGTH 271.2720 m 890.0000 L.F.

**GENERAL IMPROVEMENTS**

2" MILL AND OVERLAY(CURB WHERE NECESSARY)

**COMMENTS:**

4 RAMPS @ W BRIDGE; 2 RAMPS @ S BRIDGE

**MATERIAL ESTIMATE FOR LOCATION 24**

202000	EXCAVATION AND EMBANKMENT	30.00	C.Y.
211001	REMOVAL OF PORTLAND CEMENT CONCRETE PAVEMENT, CURB AND SIDEWALK	218.00	S.Y.
301001	GABC	19.00	C.Y.
301002	GABC, PATCHING	33.00	C.Y.
401005	SUPERPAVE TYPE C, PG 64-22 (CARBONATE STONE)	375.00	TON
401029	SUPERPAVE TYPE C, PG 64-22, PATCHING	106.00	TON
401030	SUPERPAVE TYPE B, PG 64-22, PATCHING	30.00	TON
404001	BITUMINOUS CRACK AND JOINT SEALING LESS THAN 3/4-INCH WIDE	330.00	L.F.
501001	PCC PAVEMENT, 8"	48.00	S.Y.
602130	ADJUSTING AND REPAIRING EXISTING DRAINAGE INLET	1.00	EACH
602131	ADJUSTING AND REPAIRING EXISTING DOUBLE DRAINAGE INLET	1.00	EACH
602132	ADJUSTING AND REPAIRING EXISTING MANHOLE	5.00	EACH
701013	PCC CURB, TYPE 1-8	12.00	L.F.
701019	I.PCC CURB AND GUTTER, TYPE 2	470.00	L.F.
705001	PCC SIDEWALK, 4"	188.00	S.F.
705002	PCC SIDEWALK, 6"	376.00	S.F.
705013	TRUNCATED DOME DETECTABLE WARNING SURFACE	60.00	S.F.
705008	PEDESTRIAN CONNECTION, TYPE 1	180.00	S.F.
705009	PEDESTRIAN CONNECTION, TYPE 2, 3, AND/OR 4	1,200.00	S.F.
760010	PAVEMENT MILLING, BITUMINOUS CONCRETE PAVEMENT	3,720.00	SY-IN
760011	PAVEMENT MILLING, BITUMINOUS CONCRETE PAVEMENT, TAPER CUT	1,120.00	SY-IN
762000	SAW CUTTING, BITUMINOUS CONCRETE	849.00	L.F.
762001	SAW CUTTING, CONCRETE, FULL DEPTH	85.00	L.F.
811001	FLAGGER, NEW CASTLE COUNTY	285.00	HOUR
811013	FLAGGER, NEW CASTLE COUNTY, OVERTIME	31.00	HOUR
905004	INLET SEDIMENT CONTROL, DRAINAGE INLET	3.00	EACH

DELAWARE DEPARTMENT OF TRANSPORTATION

CONTRACT T202504906

(CAD) PAGE 65 OF 84

CANAL

SUBDIVISION PAVING, NEW CASTLE COUNTY VI, 2025

---

**LOCATION 24**                      **PORTER SQUARE - DOVER COURT FROM CUL-DE-SAC TO CUL-DE-SAC**

LENGTH      271.2720 m                      890.0000 L.F.

**GENERAL IMPROVEMENTS**

2" MILL AND OVERLAY(CURB WHERE NECESSARY)

**COMMENTS:**

4 RAMPS @ W BRIDGE; 2 RAMPS @ S BRIDGE

---

**MATERIAL ESTIMATE FOR LOCATION 24**

908001	TOPSOIL	47.00	TON
908016	PERMANENT GRASS SEEDING, SUBDIVISION	280.00	S.Y.
908020	EROSION CONTROL BLANKET MULCH	280.00	S.Y.

**DELAWARE DEPARTMENT OF TRANSPORTATION**

**CONTRACT T202504906**

**(CAD) PAGE 66 OF 84**

**CANAL**

**SUBDIVISION PAVING, NEW CASTLE COUNTY VI, 2025**

**LOCATION 25 PORTER SQUARE - KENLEY COURT FROM BIGGIN HILL LANE TO END**

**LENGTH 108.2040 m 355.0000 L.F.**

**GENERAL IMPROVEMENTS**

2" MILL AND OVERLAY(CURB WHERE NECESSARY)

**COMMENTS:**

**MATERIAL ESTIMATE FOR LOCATION 25**

202000	EXCAVATION AND EMBANKMENT	25.00	C.Y.
211001	REMOVAL OF PORTLAND CEMENT CONCRETE PAVEMENT, CURB AND SIDEWALK	174.00	S.Y.
301001	GABC	15.00	C.Y.
301002	GABC, PATCHING	25.00	C.Y.
401005	SUPERPAVE TYPE C, PG 64-22 (CARBONATE STONE)	145.00	TON
401029	SUPERPAVE TYPE C, PG 64-22, PATCHING	81.00	TON
401030	SUPERPAVE TYPE B, PG 64-22, PATCHING	15.00	TON
404001	BITUMINOUS CRACK AND JOINT SEALING LESS THAN 3/4-INCH WIDE	225.00	L.F.
501001	PCC PAVEMENT, 8"	48.00	S.Y.
602132	ADJUSTING AND REPAIRING EXISTING MANHOLE	3.00	EACH
701019	I.PCC CURB AND GUTTER, TYPE 2	350.00	L.F.
705001	PCC SIDEWALK, 4"	140.00	S.F.
705002	PCC SIDEWALK, 6"	280.00	S.F.
760010	PAVEMENT MILLING, BITUMINOUS CONCRETE PAVEMENT	1,400.00	SY-IN
760011	PAVEMENT MILLING, BITUMINOUS CONCRETE PAVEMENT, TAPER CUT	430.00	SY-IN
762000	SAW CUTTING, BITUMINOUS CONCRETE	669.00	L.F.
762001	SAW CUTTING, CONCRETE, FULL DEPTH	67.00	L.F.
811001	FLAGGER, NEW CASTLE COUNTY	126.00	HOUR
811013	FLAGGER, NEW CASTLE COUNTY, OVERTIME	14.00	HOUR
908001	TOPSOIL	18.00	TON
908016	PERMANENT GRASS SEEDING, SUBDIVISION	107.00	S.Y.
908020	EROSION CONTROL BLANKET MULCH	107.00	S.Y.

DELAWARE DEPARTMENT OF TRANSPORTATION

CONTRACT T202504906

(CAD) PAGE 67 OF 84

CANAL

SUBDIVISION PAVING, NEW CASTLE COUNTY VI, 2025

---

LOCATION 26 PORTER SQUARE - MANSTON COURT FROM MIDDLE WALLOP DRIVE TO  
END

LENGTH 97.5360 m 320.0000 L.F.

GENERAL IMPROVEMENTS

2" MILL AND OVERLAY(CURB WHERE NECESSARY)

COMMENTS:

2 RAMPS @ MIDDLE WALLOP

---

MATERIAL ESTIMATE FOR LOCATION 26

202000	EXCAVATION AND EMBANKMENT	20.00	C.Y.
211001	REMOVAL OF PORTLAND CEMENT CONCRETE PAVEMENT, CURB AND SIDEWALK	87.00	S.Y.
301001	GABC	7.00	C.Y.
301002	GABC, PATCHING	15.00	C.Y.
401005	SUPERPAVE TYPE C, PG 64-22 (CARBONATE STONE)	145.00	TON
401029	SUPERPAVE TYPE C, PG 64-22, PATCHING	50.00	TON
401030	SUPERPAVE TYPE B, PG 64-22, PATCHING	10.00	TON
404001	BITUMINOUS CRACK AND JOINT SEALING LESS THAN 3/4-INCH WIDE	80.00	L.F.
602132	ADJUSTING AND REPAIRING EXISTING MANHOLE	1.00	EACH
701013	PCC CURB, TYPE 1-8	4.00	L.F.
701019	I.PCC CURB AND GUTTER, TYPE 2	240.00	L.F.
705001	PCC SIDEWALK, 4"	96.00	S.F.
705002	PCC SIDEWALK, 6"	192.00	S.F.
705013	TRUNCATED DOME DETECTABLE WARNING SURFACE	20.00	S.F.
705008	PEDESTRIAN CONNECTION, TYPE 1	60.00	S.F.
705009	PEDESTRIAN CONNECTION, TYPE 2, 3, AND/OR 4	400.00	S.F.
760010	PAVEMENT MILLING, BITUMINOUS CONCRETE PAVEMENT	1,800.00	SY-IN
760011	PAVEMENT MILLING, BITUMINOUS CONCRETE PAVEMENT, TAPER CUT	560.00	SY-IN
762000	SAW CUTTING, BITUMINOUS CONCRETE	360.00	L.F.
762001	SAW CUTTING, CONCRETE, FULL DEPTH	36.00	L.F.
811001	FLAGGER, NEW CASTLE COUNTY	106.00	HOUR
811013	FLAGGER, NEW CASTLE COUNTY, OVERTIME	13.00	HOUR
908001	TOPSOIL	18.00	TON
908016	PERMANENT GRASS SEEDING, SUBDIVISION	106.00	S.Y.
908020	EROSION CONTROL BLANKET MULCH	106.00	S.Y.

**DELAWARE DEPARTMENT OF TRANSPORTATION**

**CONTRACT T202504906**

**(CAD) PAGE 68 OF 84**

**CANAL**

**SUBDIVISION PAVING, NEW CASTLE COUNTY VI, 2025**

**LOCATION 27 PORTER SQUARE - NILSEN ROAD FROM WORTHY DOWN AVENUE TO END**

**LENGTH 426.7200 m 1400.0000 L.F.**

**GENERAL IMPROVEMENTS**

2" MILL AND OVERLAY(CURB WHERE NECESSARY)

**COMMENTS:**

INCLUDES STUB @ ANDERSON - 4 RAMPS @ ROBERTA; 6 RAMPS @ ANDERSON; 4 RAMPS @ LINDA; 4 RAMPS @ CUMMINGS

**MATERIAL ESTIMATE FOR LOCATION 27**

202000	EXCAVATION AND EMBANKMENT	40.00	C.Y.
211001	REMOVAL OF PORTLAND CEMENT CONCRETE PAVEMENT, CURB AND SIDEWALK	153.00	S.Y.
301001	GABC	12.00	C.Y.
301002	GABC, PATCHING	26.00	C.Y.
401005	SUPERPAVE TYPE C, PG 64-22 (CARBONATE STONE)	555.00	TON
401029	SUPERPAVE TYPE C, PG 64-22, PATCHING	86.00	TON
401030	SUPERPAVE TYPE B, PG 64-22, PATCHING	75.00	TON
404001	BITUMINOUS CRACK AND JOINT SEALING LESS THAN 3/4-INCH WIDE	340.00	L.F.
602130	ADJUSTING AND REPAIRING EXISTING DRAINAGE INLET	1.00	EACH
602131	ADJUSTING AND REPAIRING EXISTING DOUBLE DRAINAGE INLET	2.00	EACH
602132	ADJUSTING AND REPAIRING EXISTING MANHOLE	6.00	EACH
701013	PCC CURB, TYPE 1-8	36.00	L.F.
701019	I.PCC CURB AND GUTTER, TYPE 2	420.00	L.F.
705001	PCC SIDEWALK, 4"	168.00	S.F.
705002	PCC SIDEWALK, 6"	336.00	S.F.
705013	TRUNCATED DOME DETECTABLE WARNING SURFACE	180.00	S.F.
705008	PEDESTRIAN CONNECTION, TYPE 1	540.00	S.F.
705009	PEDESTRIAN CONNECTION, TYPE 2, 3, AND/OR 4	3,600.00	S.F.
760010	PAVEMENT MILLING, BITUMINOUS CONCRETE PAVEMENT	7,700.00	SY-IN
760011	PAVEMENT MILLING, BITUMINOUS CONCRETE PAVEMENT, TAPER CUT	560.00	SY-IN
762000	SAW CUTTING, BITUMINOUS CONCRETE	630.00	L.F.
762001	SAW CUTTING, CONCRETE, FULL DEPTH	63.00	L.F.
811001	FLAGGER, NEW CASTLE COUNTY	444.00	HOUR
811013	FLAGGER, NEW CASTLE COUNTY, OVERTIME	46.00	HOUR
905004	INLET SEDIMENT CONTROL, DRAINAGE INLET	5.00	EACH
908001	TOPSOIL	89.00	TON

DELAWARE DEPARTMENT OF TRANSPORTATION

CONTRACT T202504906

(CAD) PAGE 69 OF 84

CANAL

SUBDIVISION PAVING, NEW CASTLE COUNTY VI, 2025

---

**LOCATION 27** PORTER SQUARE - NILSEN ROAD FROM WORTHY DOWN AVENUE TO END

LENGTH 426.7200 m 1400.0000 L.F.

**GENERAL IMPROVEMENTS**

2" MILL AND OVERLAY(CURB WHERE NECESSARY)

**COMMENTS:**

INCLUDES STUB @ ANDERSON - 4 RAMPS @ ROBERTA; 6 RAMPS @ ANDERSON; 4 RAMPS @ LINDA; 4 RAMPS @ CUMMINGS

---

**MATERIAL ESTIMATE FOR LOCATION 27**

908016	PERMANENT GRASS SEEDING, SUBDIVISION	533.00	S.Y.
908020	EROSION CONTROL BLANKET MULCH	533.00	S.Y.

DELAWARE DEPARTMENT OF TRANSPORTATION

CONTRACT T202504906

(CAD) PAGE 70 OF 84

CANAL

SUBDIVISION PAVING, NEW CASTLE COUNTY VI, 2025

---

LOCATION 28 RIVERS END - BYNUM LANE FROM RED LION TERRACE SOUTH TO  
PROVIDENCE DRIVE

LENGTH 154.5336 m 507.0000 L.F.

GENERAL IMPROVEMENTS

2" MILL AND OVERLAY(CURB WHERE NECESSARY)

COMMENTS:

---

MATERIAL ESTIMATE FOR LOCATION 28

202000	EXCAVATION AND EMBANKMENT	17.00	C.Y.
211001	REMOVAL OF PORTLAND CEMENT CONCRETE PAVEMENT, CURB AND SIDEWALK	112.00	S.Y.
301001	GABC	8.00	C.Y.
301002	GABC, PATCHING	19.00	C.Y.
401005	SUPERPAVE TYPE C, PG 64-22 (CARBONATE STONE)	155.00	TON
401029	SUPERPAVE TYPE C, PG 64-22, PATCHING	63.00	TON
401030	SUPERPAVE TYPE B, PG 64-22, PATCHING	20.00	TON
404001	BITUMINOUS CRACK AND JOINT SEALING LESS THAN 3/4-INCH WIDE	124.00	L.F.
602130	ADJUSTING AND REPAIRING EXISTING DRAINAGE INLET	2.00	EACH
602132	ADJUSTING AND REPAIRING EXISTING MANHOLE	2.00	EACH
701019	I.PCC CURB AND GUTTER, TYPE 2	310.00	L.F.
705001	PCC SIDEWALK, 4"	124.00	S.F.
705002	PCC SIDEWALK, 6"	248.00	S.F.
760010	PAVEMENT MILLING, BITUMINOUS CONCRETE PAVEMENT	2,480.00	SY-IN
762000	SAW CUTTING, BITUMINOUS CONCRETE	465.00	L.F.
762001	SAW CUTTING, CONCRETE, FULL DEPTH	47.00	L.F.
811001	FLAGGER, NEW CASTLE COUNTY	127.00	HOURL
811013	FLAGGER, NEW CASTLE COUNTY, OVERTIME	13.00	HOURL
905004	INLET SEDIMENT CONTROL, DRAINAGE INLET	2.00	EACH
908001	TOPSOIL	12.00	TON
908016	PERMANENT GRASS SEEDING, SUBDIVISION	74.00	S.Y.
908020	EROSION CONTROL BLANKET MULCH	74.00	S.Y.

**DELAWARE DEPARTMENT OF TRANSPORTATION**

**CONTRACT T202504906**

**(CAD) PAGE 71 OF 84**

**CANAL**

**SUBDIVISION PAVING, NEW CASTLE COUNTY VI, 2025**

**LOCATION 29 RIVERS END - WALDEN COURT FROM RED CLAY DRIVE TO END**

**LENGTH 73.1520 m 240.0000 L.F.**

**GENERAL IMPROVEMENTS**

2" MILL AND OVERLAY(CURB WHERE NECESSARY)

**COMMENTS:**

**MATERIAL ESTIMATE FOR LOCATION 29**

202000	EXCAVATION AND EMBANKMENT	20.00	C.Y.
211001	REMOVAL OF PORTLAND CEMENT CONCRETE PAVEMENT, CURB AND SIDEWALK	112.00	S.Y.
301001	GABC	8.00	C.Y.
301002	GABC, PATCHING	19.00	C.Y.
401005	SUPERPAVE TYPE C, PG 64-22 (CARBONATE STONE)	95.00	TON
401029	SUPERPAVE TYPE C, PG 64-22, PATCHING	63.00	TON
401030	SUPERPAVE TYPE B, PG 64-22, PATCHING	15.00	TON
404001	BITUMINOUS CRACK AND JOINT SEALING LESS THAN 3/4-INCH WIDE	77.00	L.F.
602130	ADJUSTING AND REPAIRING EXISTING DRAINAGE INLET	1.00	EACH
602132	ADJUSTING AND REPAIRING EXISTING MANHOLE	1.00	EACH
701019	I.PCC CURB AND GUTTER, TYPE 2	310.00	L.F.
705001	PCC SIDEWALK, 4"	124.00	S.F.
705002	PCC SIDEWALK, 6"	248.00	S.F.
760010	PAVEMENT MILLING, BITUMINOUS CONCRETE PAVEMENT	1,480.00	SY-IN
762000	SAW CUTTING, BITUMINOUS CONCRETE	465.00	L.F.
762001	SAW CUTTING, CONCRETE, FULL DEPTH	47.00	L.F.
811001	FLAGGER, NEW CASTLE COUNTY	95.00	HOURLY
811013	FLAGGER, NEW CASTLE COUNTY, OVERTIME	11.00	HOURLY
905004	INLET SEDIMENT CONTROL, DRAINAGE INLET	1.00	EACH
908001	TOPSOIL	12.00	TON
908016	PERMANENT GRASS SEEDING, SUBDIVISION	74.00	S.Y.
908020	EROSION CONTROL BLANKET MULCH	74.00	S.Y.

**DELAWARE DEPARTMENT OF TRANSPORTATION**

**CONTRACT T202504906**

**(CAD) PAGE 72 OF 84**

**CANAL**

**SUBDIVISION PAVING, NEW CASTLE COUNTY VI, 2025**

**LOCATION 30 RIVERS END - WHITE ROCK ROAD FROM SMALLEYS DAM ROAD TO TURN-A-ROUND**

LENGTH 204.2160 m 670.0000 L.F.

**GENERAL IMPROVEMENTS**

2" MILL AND OVERLAY(CURB WHERE NECESSARY)

**COMMENTS:**

**MATERIAL ESTIMATE FOR LOCATION 30**

202000	EXCAVATION AND EMBANKMENT	30.00	C.Y.
211001	REMOVAL OF PORTLAND CEMENT CONCRETE PAVEMENT, CURB AND SIDEWALK	151.00	S.Y.
301001	GABC	11.00	C.Y.
301002	GABC, PATCHING	25.00	C.Y.
401005	SUPERPAVE TYPE C, PG 64-22 (CARBONATE STONE)	225.00	TON
401029	SUPERPAVE TYPE C, PG 64-22, PATCHING	85.00	TON
401030	SUPERPAVE TYPE B, PG 64-22, PATCHING	30.00	TON
404001	BITUMINOUS CRACK AND JOINT SEALING LESS THAN 3/4-INCH WIDE	138.00	L.F.
602130	ADJUSTING AND REPAIRING EXISTING DRAINAGE INLET	3.00	EACH
602132	ADJUSTING AND REPAIRING EXISTING MANHOLE	4.00	EACH
701019	I.PCC CURB AND GUTTER, TYPE 2	420.00	L.F.
705001	PCC SIDEWALK, 4"	168.00	S.F.
705002	PCC SIDEWALK, 6"	336.00	S.F.
760010	PAVEMENT MILLING, BITUMINOUS CONCRETE PAVEMENT	3,580.00	SY-IN
762000	SAW CUTTING, BITUMINOUS CONCRETE	630.00	L.F.
762001	SAW CUTTING, CONCRETE, FULL DEPTH	63.00	L.F.
811001	FLAGGER, NEW CASTLE COUNTY	183.00	HOURL
811013	FLAGGER, NEW CASTLE COUNTY, OVERTIME	20.00	HOURL
905004	INLET SEDIMENT CONTROL, DRAINAGE INLET	6.00	EACH
908001	TOPSOIL	17.00	TON
908016	PERMANENT GRASS SEEDING, SUBDIVISION	101.00	S.Y.
908020	EROSION CONTROL BLANKET MULCH	101.00	S.Y.

DELAWARE DEPARTMENT OF TRANSPORTATION

CONTRACT T202504906

(CAD) PAGE 73 OF 84

CANAL

SUBDIVISION PAVING, NEW CASTLE COUNTY VI, 2025

---

LOCATION 31 SALEM WOODS - BERLEY COURT FROM JAYMAR BOULEVARD TO END

LENGTH 163.0680 m 535.0000 L.F.

GENERAL IMPROVEMENTS

2" MILL AND OVERLAY(CURB WHERE NECESSARY)

COMMENTS:

---

MATERIAL ESTIMATE FOR LOCATION 31

202000	EXCAVATION AND EMBANKMENT	20.00	C.Y.
211001	REMOVAL OF PORTLAND CEMENT CONCRETE PAVEMENT, CURB AND SIDEWALK	162.00	S.Y.
301001	GABC	11.00	C.Y.
301002	GABC, PATCHING	27.00	C.Y.
401005	SUPERPAVE TYPE C, PG 64-22 (CARBONATE STONE)	250.00	TON
401029	SUPERPAVE TYPE C, PG 64-22, PATCHING	91.00	TON
401030	SUPERPAVE TYPE B, PG 64-22, PATCHING	20.00	TON
404001	BITUMINOUS CRACK AND JOINT SEALING LESS THAN 3/4-INCH WIDE	140.00	L.F.
602130	ADJUSTING AND REPAIRING EXISTING DRAINAGE INLET	2.00	EACH
602131	ADJUSTING AND REPAIRING EXISTING DOUBLE DRAINAGE INLET	1.00	EACH
602132	ADJUSTING AND REPAIRING EXISTING MANHOLE	3.00	EACH
701019	I.PCC CURB AND GUTTER, TYPE 2	450.00	L.F.
705001	PCC SIDEWALK, 4"	180.00	S.F.
705002	PCC SIDEWALK, 6"	360.00	S.F.
760010	PAVEMENT MILLING, BITUMINOUS CONCRETE PAVEMENT	2,260.00	SY-IN
760011	PAVEMENT MILLING, BITUMINOUS CONCRETE PAVEMENT, TAPER CUT	750.00	SY-IN
762000	SAW CUTTING, BITUMINOUS CONCRETE	675.00	L.F.
762001	SAW CUTTING, CONCRETE, FULL DEPTH	68.00	L.F.
811001	FLAGGER, NEW CASTLE COUNTY	182.00	HOUR
811013	FLAGGER, NEW CASTLE COUNTY, OVERTIME	19.00	HOUR
905004	INLET SEDIMENT CONTROL, DRAINAGE INLET	4.00	EACH
908001	TOPSOIL	18.00	TON
908016	PERMANENT GRASS SEEDING, SUBDIVISION	108.00	S.Y.
908020	EROSION CONTROL BLANKET MULCH	108.00	S.Y.

**DELAWARE DEPARTMENT OF TRANSPORTATION**

**CONTRACT T202504906**

**(CAD) PAGE 74 OF 84**

**CANAL**

**SUBDIVISION PAVING, NEW CASTLE COUNTY VI, 2025**

**LOCATION 32 SALEM WOODS - LOUIS COURT FROM JAYMAR BOULEVARD TO END**

**LENGTH 67.0560 m 220.0000 L.F.**

**GENERAL IMPROVEMENTS**

2" MILL AND OVERLAY(CURB WHERE NECESSARY)

**COMMENTS:**

2 RAMPS @ JAYMAR

**MATERIAL ESTIMATE FOR LOCATION 32**

202000	EXCAVATION AND EMBANKMENT	10.00	C.Y.
211001	REMOVAL OF PORTLAND CEMENT CONCRETE PAVEMENT, CURB AND SIDEWALK	55.00	S.Y.
301001	GABC	5.00	C.Y.
301002	GABC, PATCHING	10.00	C.Y.
401005	SUPERPAVE TYPE C, PG 64-22 (CARBONATE STONE)	140.00	TON
401029	SUPERPAVE TYPE C, PG 64-22, PATCHING	32.00	TON
401030	SUPERPAVE TYPE B, PG 64-22, PATCHING	10.00	TON
404001	BITUMINOUS CRACK AND JOINT SEALING LESS THAN 3/4-INCH WIDE	61.00	L.F.
602131	ADJUSTING AND REPAIRING EXISTING DOUBLE DRAINAGE INLET	1.00	EACH
602132	ADJUSTING AND REPAIRING EXISTING MANHOLE	1.00	EACH
701013	PCC CURB, TYPE 1-8	4.00	L.F.
701019	I.PCC CURB AND GUTTER, TYPE 2	150.00	L.F.
705001	PCC SIDEWALK, 4"	60.00	S.F.
705002	PCC SIDEWALK, 6"	120.00	S.F.
705013	TRUNCATED DOME DETECTABLE WARNING SURFACE	20.00	S.F.
705008	PEDESTRIAN CONNECTION, TYPE 1	60.00	S.F.
705009	PEDESTRIAN CONNECTION, TYPE 2, 3, AND/OR 4	400.00	S.F.
760010	PAVEMENT MILLING, BITUMINOUS CONCRETE PAVEMENT	1,080.00	SY-IN
760011	PAVEMENT MILLING, BITUMINOUS CONCRETE PAVEMENT, TAPER CUT	560.00	SY-IN
762000	SAW CUTTING, BITUMINOUS CONCRETE	225.00	L.F.
762001	SAW CUTTING, CONCRETE, FULL DEPTH	23.00	L.F.
811001	FLAGGER, NEW CASTLE COUNTY	92.00	hour
811013	FLAGGER, NEW CASTLE COUNTY, OVERTIME	11.00	hour
905004	INLET SEDIMENT CONTROL, DRAINAGE INLET	2.00	EACH
908001	TOPSOIL	14.00	TON
908016	PERMANENT GRASS SEEDING, SUBDIVISION	84.00	S.Y.

**DELAWARE DEPARTMENT OF TRANSPORTATION**

**CONTRACT T202504906**

**(CAD) PAGE 75 OF 84**

**CANAL**

**SUBDIVISION PAVING, NEW CASTLE COUNTY VI, 2025**

---

**LOCATION 32 SALEM WOODS - LOUIS COURT FROM JAYMAR BOULEVARD TO END**

**LENGTH 67.0560 m 220.0000 L.F.**

**GENERAL IMPROVEMENTS**

**2" MILL AND OVERLAY(CURB WHERE NECESSARY)**

**COMMENTS:**

**2 RAMPS @ JAYMAR**

---

**MATERIAL ESTIMATE FOR LOCATION 32**

**908020 EROSION CONTROL BLANKET MULCH**

**84.00 S.Y.**

**DELAWARE DEPARTMENT OF TRANSPORTATION**

**CONTRACT T202504906**

**(CAD) PAGE 76 OF 84**

**CANAL**

**SUBDIVISION PAVING, NEW CASTLE COUNTY VI, 2025**

**LOCATION 33 SALEM WOODS - PAUL COURT FROM FLINTHILL DRIVE TO END**

**LENGTH 64.0080 m 210.0000 L.F.**

**GENERAL IMPROVEMENTS**

2" MILL AND OVERLAY(CURB WHERE NECESSARY)

**COMMENTS:**

**MATERIAL ESTIMATE FOR LOCATION 33**

202000	EXCAVATION AND EMBANKMENT	10.00	C.Y.
211001	REMOVAL OF PORTLAND CEMENT CONCRETE PAVEMENT, CURB AND SIDEWALK	54.00	S.Y.
301001	GABC	4.00	C.Y.
301002	GABC, PATCHING	9.00	C.Y.
401005	SUPERPAVE TYPE C, PG 64-22 (CARBONATE STONE)	100.00	TON
401029	SUPERPAVE TYPE C, PG 64-22, PATCHING	31.00	TON
401030	SUPERPAVE TYPE B, PG 64-22, PATCHING	10.00	TON
404001	BITUMINOUS CRACK AND JOINT SEALING LESS THAN 3/4-INCH WIDE	85.00	L.F.
602130	ADJUSTING AND REPAIRING EXISTING DRAINAGE INLET	3.00	EACH
602131	ADJUSTING AND REPAIRING EXISTING DOUBLE DRAINAGE INLET	1.00	EACH
602132	ADJUSTING AND REPAIRING EXISTING MANHOLE	2.00	EACH
701019	I.PCC CURB AND GUTTER, TYPE 2	150.00	L.F.
705001	PCC SIDEWALK, 4"	60.00	S.F.
705002	PCC SIDEWALK, 6"	120.00	S.F.
760010	PAVEMENT MILLING, BITUMINOUS CONCRETE PAVEMENT	700.00	SY-IN
760011	PAVEMENT MILLING, BITUMINOUS CONCRETE PAVEMENT, TAPER CUT	430.00	SY-IN
762000	SAW CUTTING, BITUMINOUS CONCRETE	225.00	L.F.
762001	SAW CUTTING, CONCRETE, FULL DEPTH	23.00	L.F.
811001	FLAGGER, NEW CASTLE COUNTY	91.00	HOUR
811013	FLAGGER, NEW CASTLE COUNTY, OVERTIME	12.00	HOUR
905004	INLET SEDIMENT CONTROL, DRAINAGE INLET	5.00	EACH
908001	TOPSOIL	6.00	TON
908016	PERMANENT GRASS SEEDING, SUBDIVISION	36.00	S.Y.
908020	EROSION CONTROL BLANKET MULCH	36.00	S.Y.

DELAWARE DEPARTMENT OF TRANSPORTATION

CONTRACT T202504906

(CAD) PAGE 77 OF 84

CANAL

SUBDIVISION PAVING, NEW CASTLE COUNTY VI, 2025

---

**LOCATION 34 SPARROW RUN - RAVEN TURN FROM FLAMINGO DRIVE TO END**

LENGTH 243.8400 m 800.0000 L.F.

**GENERAL IMPROVEMENTS**

2" MILL AND OVERLAY(CURB WHERE NECESSARY)

**COMMENTS:**

---

**MATERIAL ESTIMATE FOR LOCATION 34**

202000	EXCAVATION AND EMBANKMENT	35.00	C.Y.
211001	REMOVAL OF PORTLAND CEMENT CONCRETE PAVEMENT, CURB AND SIDEWALK	324.00	S.Y.
301001	GABC	23.00	C.Y.
301002	GABC, PATCHING	54.00	C.Y.
401005	SUPERPAVE TYPE C, PG 64-22 (CARBONATE STONE)	300.00	TON
401029	SUPERPAVE TYPE C, PG 64-22, PATCHING	181.00	TON
401030	SUPERPAVE TYPE B, PG 64-22, PATCHING	30.00	TON
404001	BITUMINOUS CRACK AND JOINT SEALING LESS THAN 3/4-INCH WIDE	232.00	L.F.
602130	ADJUSTING AND REPAIRING EXISTING DRAINAGE INLET	4.00	EACH
602132	ADJUSTING AND REPAIRING EXISTING MANHOLE	6.00	EACH
701019	I.PCC CURB AND GUTTER, TYPE 2	900.00	L.F.
705001	PCC SIDEWALK, 4"	360.00	S.F.
705002	PCC SIDEWALK, 6"	720.00	S.F.
710002	ADJUST WATER VALVE BOXES	2.00	EACH
760010	PAVEMENT MILLING, BITUMINOUS CONCRETE PAVEMENT	3,600.00	SY-IN
760011	PAVEMENT MILLING, BITUMINOUS CONCRETE PAVEMENT, TAPER CUT	560.00	SY-IN
762000	SAW CUTTING, BITUMINOUS CONCRETE	1,350.00	L.F.
762001	SAW CUTTING, CONCRETE, FULL DEPTH	135.00	L.F.
811001	FLAGGER, NEW CASTLE COUNTY	293.00	HOUR
811013	FLAGGER, NEW CASTLE COUNTY, OVERTIME	32.00	HOUR
905004	INLET SEDIMENT CONTROL, DRAINAGE INLET	4.00	EACH
908001	TOPSOIL	36.00	TON
908016	PERMANENT GRASS SEEDING, SUBDIVISION	216.00	S.Y.
908020	EROSION CONTROL BLANKET MULCH	216.00	S.Y.

**DELAWARE DEPARTMENT OF TRANSPORTATION**

**CONTRACT T202504906**

**(CAD) PAGE 78 OF 84**

**CANAL**

**SUBDIVISION PAVING, NEW CASTLE COUNTY VI, 2025**

**LOCATION 35 SUMMERHILL(ASPEN WDS) - SUMAC COURT FROM CURRANT DRIVE TO  
END**

LENGTH 367.2840 m 1205.0000 L.F.

**GENERAL IMPROVEMENTS**

2" MILL AND OVERLAY(CURB WHERE NECESSARY)

**COMMENTS:**

**MATERIAL ESTIMATE FOR LOCATION 35**

202000	EXCAVATION AND EMBANKMENT	35.00	C.Y.
211001	REMOVAL OF PORTLAND CEMENT CONCRETE PAVEMENT, CURB AND SIDEWALK	263.00	S.Y.
301001	GABC	18.00	C.Y.
301002	GABC, PATCHING	44.00	C.Y.
401005	SUPERPAVE TYPE C, PG 64-22 (CARBONATE STONE)	445.00	TON
401029	SUPERPAVE TYPE C, PG 64-22, PATCHING	147.00	TON
401030	SUPERPAVE TYPE B, PG 64-22, PATCHING	50.00	TON
404001	BITUMINOUS CRACK AND JOINT SEALING LESS THAN 3/4-INCH WIDE	263.00	L.F.
602132	ADJUSTING AND REPAIRING EXISTING MANHOLE	7.00	EACH
701019	I.PCC CURB AND GUTTER, TYPE 2	730.00	L.F.
705001	PCC SIDEWALK, 4"	292.00	S.F.
705002	PCC SIDEWALK, 6"	584.00	S.F.
710002	ADJUST WATER VALVE BOXES	1.00	EACH
710370	STEEL CASING PIPE, 4"	20.00	L.F.
760010	PAVEMENT MILLING, BITUMINOUS CONCRETE PAVEMENT	5,500.00	SY-IN
760011	PAVEMENT MILLING, BITUMINOUS CONCRETE PAVEMENT, TAPER CUT	860.00	SY-IN
762000	SAW CUTTING, BITUMINOUS CONCRETE	1,095.00	L.F.
762001	SAW CUTTING, CONCRETE, FULL DEPTH	110.00	L.F.
811001	FLAGGER, NEW CASTLE COUNTY	289.00	HOURLY
811013	FLAGGER, NEW CASTLE COUNTY, OVERTIME	31.00	HOURLY
905004	INLET SEDIMENT CONTROL, DRAINAGE INLET	10.00	EACH
908001	TOPSOIL	29.00	TON
908016	PERMANENT GRASS SEEDING, SUBDIVISION	175.00	S.Y.
908020	EROSION CONTROL BLANKET MULCH	175.00	S.Y.

**DELAWARE DEPARTMENT OF TRANSPORTATION**

**CONTRACT T202504906**

**(CAD) PAGE 79 OF 84**

**CANAL**

**SUBDIVISION PAVING, NEW CASTLE COUNTY VI, 2025**

**LOCATION 36 TAYLORTOWNE - STRAUSS WAY FROM OPUS DRIVE TO TAYLOR DRIVE**

**LENGTH 150.8760 m 495.0000 L.F.**

**GENERAL IMPROVEMENTS**

2" MILL AND OVERLAY(CURB WHERE NECESSARY)

**COMMENTS:**

**MATERIAL ESTIMATE FOR LOCATION 36**

202000	EXCAVATION AND EMBANKMENT	15.00	C.Y.
211001	REMOVAL OF PORTLAND CEMENT CONCRETE PAVEMENT, CURB AND SIDEWALK	94.00	S.Y.
301001	GABC	7.00	C.Y.
301002	GABC, PATCHING	16.00	C.Y.
401005	SUPERPAVE TYPE C, PG 64-22 (CARBONATE STONE)	155.00	TON
401029	SUPERPAVE TYPE C, PG 64-22, PATCHING	53.00	TON
401030	SUPERPAVE TYPE B, PG 64-22, PATCHING	20.00	TON
404001	BITUMINOUS CRACK AND JOINT SEALING LESS THAN 3/4-INCH WIDE	70.00	L.F.
602130	ADJUSTING AND REPAIRING EXISTING DRAINAGE INLET	1.00	EACH
602132	ADJUSTING AND REPAIRING EXISTING MANHOLE	1.00	EACH
701019	I.PCC CURB AND GUTTER, TYPE 2	260.00	L.F.
705001	PCC SIDEWALK, 4"	104.00	S.F.
705002	PCC SIDEWALK, 6"	208.00	S.F.
760010	PAVEMENT MILLING, BITUMINOUS CONCRETE PAVEMENT	2,500.00	SY-IN
762000	SAW CUTTING, BITUMINOUS CONCRETE	390.00	L.F.
762001	SAW CUTTING, CONCRETE, FULL DEPTH	39.00	L.F.
811001	FLAGGER, NEW CASTLE COUNTY	105.00	HOUR
811013	FLAGGER, NEW CASTLE COUNTY, OVERTIME	11.00	HOUR
905004	INLET SEDIMENT CONTROL, DRAINAGE INLET	2.00	EACH
908001	TOPSOIL	10.00	TON
908016	PERMANENT GRASS SEEDING, SUBDIVISION	62.00	S.Y.
908020	EROSION CONTROL BLANKET MULCH	62.00	S.Y.

DELAWARE DEPARTMENT OF TRANSPORTATION

CONTRACT T202504906

(CAD) PAGE 80 OF 84

CANAL

SUBDIVISION PAVING, NEW CASTLE COUNTY VI, 2025

---

LOCATION 37 VILLAGES AT FAIRVIEW FARM - EAST WAYNE WAY FROM SHENANDOAH STREET TO END

LENGTH 201.1680 m 660.0000 L.F.

GENERAL IMPROVEMENTS

2" MILL AND OVERLAY

COMMENTS:

---

MATERIAL ESTIMATE FOR LOCATION 37

202000	EXCAVATION AND EMBANKMENT	10.00	C.Y.
401005	SUPERPAVE TYPE C, PG 64-22 (CARBONATE STONE)	285.00	TON
401029	SUPERPAVE TYPE C, PG 64-22, PATCHING	1.00	TON
401030	SUPERPAVE TYPE B, PG 64-22, PATCHING	30.00	TON
404001	BITUMINOUS CRACK AND JOINT SEALING LESS THAN 3/4-INCH WIDE	22.00	L.F.
760010	PAVEMENT MILLING, BITUMINOUS CONCRETE PAVEMENT	3,440.00	SY-IN
760011	PAVEMENT MILLING, BITUMINOUS CONCRETE PAVEMENT, TAPER CUT	560.00	SY-IN
762000	SAW CUTTING, BITUMINOUS CONCRETE	200.00	L.F.
811001	FLAGGER, NEW CASTLE COUNTY	95.00	HOUR
811013	FLAGGER, NEW CASTLE COUNTY, OVERTIME	11.00	HOUR

DELAWARE DEPARTMENT OF TRANSPORTATION

CONTRACT T202504906

(CAD) PAGE 81 OF 84

CANAL

SUBDIVISION PAVING, NEW CASTLE COUNTY VI, 2025

---

LOCATION 38 WOODLAND VILLAGE - ALDRIDGE COURT FROM MCCORMICK BLVD TO  
END

LENGTH 99.0600 m 325.0000 L.F.

**GENERAL IMPROVEMENTS**

2" MILL AND OVERLAY (CURB WHERE NECESSARY)

**COMMENTS:**

2 RAMPS @ MCCORMICK

---

**MATERIAL ESTIMATE FOR LOCATION 38**

202000	EXCAVATION AND EMBANKMENT	15.00	C.Y.
211001	REMOVAL OF PORTLAND CEMENT CONCRETE PAVEMENT, CURB AND SIDEWALK	1.00	S.Y.
301001	GABC	1.00	C.Y.
301002	GABC, PATCHING	1.00	C.Y.
401005	SUPERPAVE TYPE C, PG 64-22 (CARBONATE STONE)	145.00	TON
401029	SUPERPAVE TYPE C, PG 64-22, PATCHING	2.00	TON
401030	SUPERPAVE TYPE B, PG 64-22, PATCHING	20.00	TON
404001	BITUMINOUS CRACK AND JOINT SEALING LESS THAN 3/4-INCH WIDE	70.00	L.F.
602131	ADJUSTING AND REPAIRING EXISTING DOUBLE DRAINAGE INLET	1.00	EACH
602132	ADJUSTING AND REPAIRING EXISTING MANHOLE	2.00	EACH
701013	PCC CURB, TYPE 1-8	4.00	L.F.
705013	TRUNCATED DOME DETECTABLE WARNING SURFACE	20.00	S.F.
705008	PEDESTRIAN CONNECTION, TYPE 1	60.00	S.F.
705009	PEDESTRIAN CONNECTION, TYPE 2, 3, AND/OR 4	400.00	S.F.
760010	PAVEMENT MILLING, BITUMINOUS CONCRETE PAVEMENT	1,200.00	SY-IN
760011	PAVEMENT MILLING, BITUMINOUS CONCRETE PAVEMENT, TAPER CUT	560.00	SY-IN
811001	FLAGGER, NEW CASTLE COUNTY	76.00	HOURLY
811013	FLAGGER, NEW CASTLE COUNTY, OVERTIME	9.00	HOURLY
905004	INLET SEDIMENT CONTROL, DRAINAGE INLET	2.00	EACH
908001	TOPSOIL	8.00	TON
908016	PERMANENT GRASS SEEDING, SUBDIVISION	48.00	S.Y.
908020	EROSION CONTROL BLANKET MULCH	48.00	S.Y.

**DELAWARE DEPARTMENT OF TRANSPORTATION**

**CONTRACT T202504906**

**(CAD) PAGE 82 OF 84**

**CANAL**

**SUBDIVISION PAVING, NEW CASTLE COUNTY VI, 2025**

**LOCATION 39 WOODLAND VILLAGE - EVERGREEN DRIVE FROM MCCORMICK BOULEVARD TO END**

LENGTH 316.9920 m 1040.0000 L.F.

**GENERAL IMPROVEMENTS**

2" MILL AND OVERLAY(CURB WHERE NECESSARY)

**COMMENTS:**

**MATERIAL ESTIMATE FOR LOCATION 39**

202000	EXCAVATION AND EMBANKMENT	30.00	C.Y.
211001	REMOVAL OF PORTLAND CEMENT CONCRETE PAVEMENT, CURB AND SIDEWALK	184.00	S.Y.
301001	GABC	13.00	C.Y.
301002	GABC, PATCHING	31.00	C.Y.
401005	SUPERPAVE TYPE C, PG 64-22 (CARBONATE STONE)	265.00	TON
401029	SUPERPAVE TYPE C, PG 64-22, PATCHING	103.00	TON
401030	SUPERPAVE TYPE B, PG 64-22, PATCHING	35.00	TON
404001	BITUMINOUS CRACK AND JOINT SEALING LESS THAN 3/4-INCH WIDE	285.00	L.F.
602130	ADJUSTING AND REPAIRING EXISTING DRAINAGE INLET	1.00	EACH
602131	ADJUSTING AND REPAIRING EXISTING DOUBLE DRAINAGE INLET	2.00	EACH
602132	ADJUSTING AND REPAIRING EXISTING MANHOLE	6.00	EACH
701019	I.PCC CURB AND GUTTER, TYPE 2	510.00	L.F.
705001	PCC SIDEWALK, 4"	204.00	S.F.
705002	PCC SIDEWALK, 6"	408.00	S.F.
760010	PAVEMENT MILLING, BITUMINOUS CONCRETE PAVEMENT	4,220.00	SY-IN
762000	SAW CUTTING, BITUMINOUS CONCRETE	765.00	L.F.
762001	SAW CUTTING, CONCRETE, FULL DEPTH	77.00	L.F.
811001	FLAGGER, NEW CASTLE COUNTY	220.00	HOUR
811013	FLAGGER, NEW CASTLE COUNTY, OVERTIME	22.00	HOUR
905004	INLET SEDIMENT CONTROL, DRAINAGE INLET	5.00	EACH
908001	TOPSOIL	20.00	TON
908016	PERMANENT GRASS SEEDING, SUBDIVISION	122.00	S.Y.
908020	EROSION CONTROL BLANKET MULCH	122.00	S.Y.

---

DELAWARE DEPARTMENT OF TRANSPORTATION

CONTRACT T202504906

(CAD) PAGE 83 OF 84

CANAL

SUBDIVISION PAVING, NEW CASTLE COUNTY VI, 2025

---

CONTRACT QUANTITIES SUMMARY SHEET

201000	CLEARING AND GRUBBING	1.00	L.S.
202000	EXCAVATION AND EMBANKMENT	816.00	C.Y.
211001	REMOVAL OF PORTLAND CEMENT CONCRETE PAVEMENT, CURB AND SIDEWALK	4,013.00	S.Y.
301001	GABC	301.00	C.Y.
301002	GABC, PATCHING	673.00	C.Y.
401005	SUPERPAVE TYPE C, PG 64-22 (CARBONATE STONE)	9,240.00	TON
401029	SUPERPAVE TYPE C, PG 64-22, PATCHING	2,252.00	TON
401030	SUPERPAVE TYPE B, PG 64-22, PATCHING	1,191.00	TON
404001	BITUMINOUS CRACK AND JOINT SEALING LESS THAN 3/4-INCH WIDE	5,427.00	L.F.
501001	PCC PAVEMENT, 8"	96.00	S.Y.
504001	CRACK AND JOINT SEALING LESS THAN 3/4 INCH WIDE	17.00	L.F.
602100	DRAINAGE INLET GRATE(S)	2.00	EACH
602101	DRAINAGE INLET FRAME(S)	1.00	EACH
602102	MANHOLE COVER(S)	3.00	EACH
602103	MANHOLE FRAME(S)	3.00	EACH
602130	ADJUSTING AND REPAIRING EXISTING DRAINAGE INLET	35.00	EACH
602131	ADJUSTING AND REPAIRING EXISTING DOUBLE DRAINAGE INLET	27.00	EACH
602132	ADJUSTING AND REPAIRING EXISTING MANHOLE	112.00	EACH
701013	PCC CURB, TYPE 1-8	114.00	L.F.
701018	I.PCC CURB AND GUTTER, TYPE 1-8	90.00	L.F.
701019	I.PCC CURB AND GUTTER, TYPE 2	10,780.00	L.F.
705001	PCC SIDEWALK, 4"	4,328.00	S.F.
705002	PCC SIDEWALK, 6"	8,656.00	S.F.
705013	TRUNCATED DOME DETECTABLE WARNING SURFACE	570.00	S.F.
705008	PEDESTRIAN CONNECTION, TYPE 1	1,710.00	S.F.
705009	PEDESTRIAN CONNECTION, TYPE 2, 3, AND/OR 4	11,400.00	S.F.
710002	ADJUST WATER VALVE BOXES	14.00	EACH
710370	STEEL CASING PIPE, 4"	40.00	L.F.

---

DELAWARE DEPARTMENT OF TRANSPORTATION

CONTRACT T202504906

(CAD) PAGE 84 OF 84

CANAL

SUBDIVISION PAVING, NEW CASTLE COUNTY VI, 2025

---

CONTRACT QUANTITIES SUMMARY SHEET

760010	PAVEMENT MILLING, BITUMINOUS CONCRETE PAVEMENT	121,830.00	SY-IN
760011	PAVEMENT MILLING, BITUMINOUS CONCRETE PAVEMENT, TAPER CUT	11,985.00	SY-IN
762000	SAW CUTTING, BITUMINOUS CONCRETE	18,634.00	L.F.
762001	SAW CUTTING, CONCRETE, FULL DEPTH	1,736.00	L.F.
763000	INITIAL EXPENSE/DE-MOBILIZATION	LUMP	SUM
801500	MAINTENANCE OF TRAFFIC, ALL INCLUSIVE	LUMP	SUM
802003	ARROW PANELS TYPE C	6.00	EA-DY
808002	PROVIDE AND MAINTAIN TRUCK MOUNTED ATTENUATOR, TYPE II	7.00	EA-DY
811001	FLAGGER, NEW CASTLE COUNTY	6,205.00	HOUR
811013	FLAGGER, NEW CASTLE COUNTY, OVERTIME	676.00	HOUR
817002	PERMANENT PAVEMENT STRIPING, SYMBOL/LEGEND, ALKYD-THERMOPLASTIC	33.00	S.F.
817004	TEMPORARY MARKINGS, PAINT, SYMBOL/LEGEND	33.00	S.F.
819018	INSTALLATION OR REMOVAL OF TRAFFIC SIGN(S) ON SINGLE SIGN POST	2.00	EACH
905004	INLET SEDIMENT CONTROL, DRAINAGE INLET	109.00	EACH
908001	TOPSOIL	668.00	TON
908016	PERMANENT GRASS SEEDING, SUBDIVISION	4,010.00	S.Y.
908020	EROSION CONTROL BLANKET MULCH	4,010.00	S.Y.